

Akcesoria drzwiowe

POCHWYTY typ "Q"



akcesoria drzwiowe

2025





Akcesoria drzwiowe

POCHWYTY typ "Q"**Spis treści**

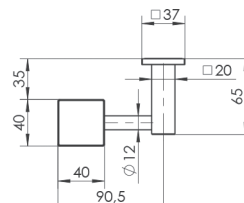
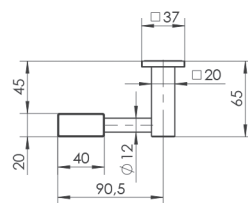
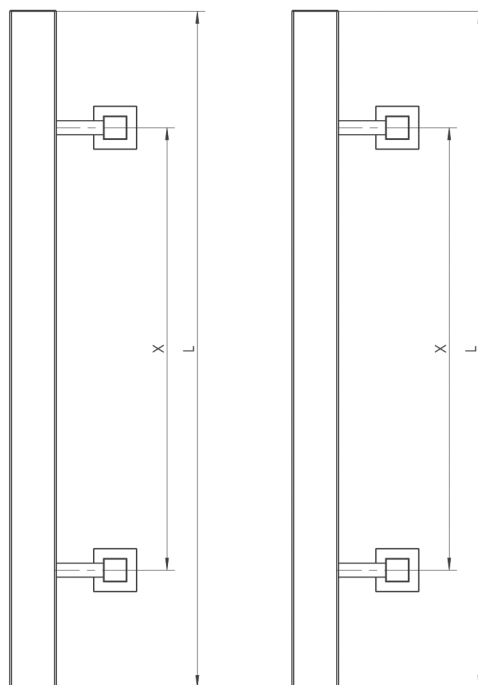
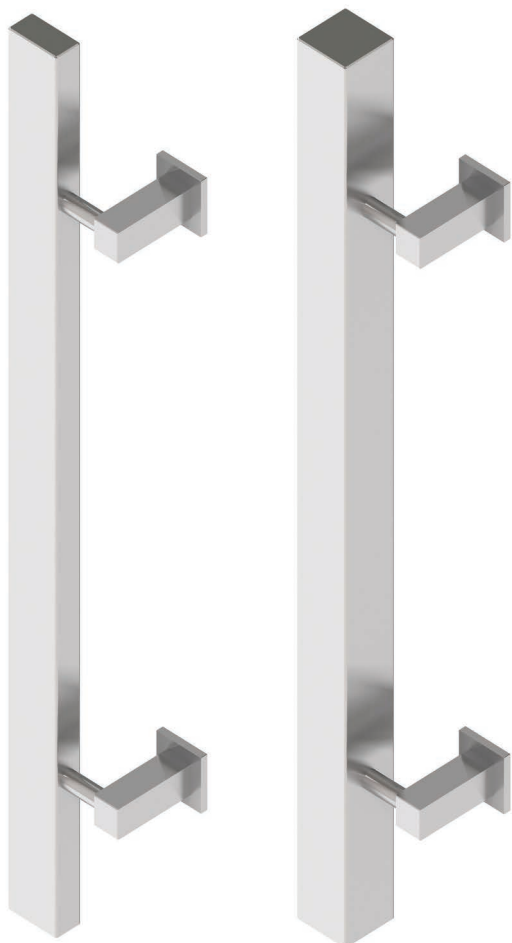
Pochwył Q5	2
Pochwył Q10	4
Pochwył QA10	5
Pochwył Q10B	6
Pochwył Q10D	7
Pochwył Q10RX	8
Pochwył QA10RX	9
Pochwył Q10RXD	10
Pochwył Q45	11
Pochwył QA45	12
Pochwył Q45D	13
Pochwył Q45RX	14
Pochwył QA45RX	15
Pochwył Q45RXD	16
Pochwył Q60	17
Pochwył Q90	18
Pochwył Q135	26
Pochwył QAX	30
Pochwył Q45P	32
Pochwył Q10ZX	33
Pochwyły PS, OS, QS	34
Zestawy mocujące	37
Oznaczenia	52

Pochwyt Q5

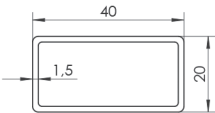
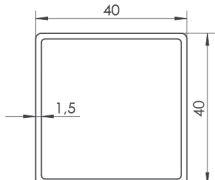



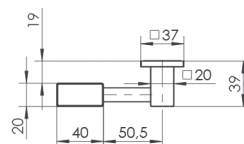
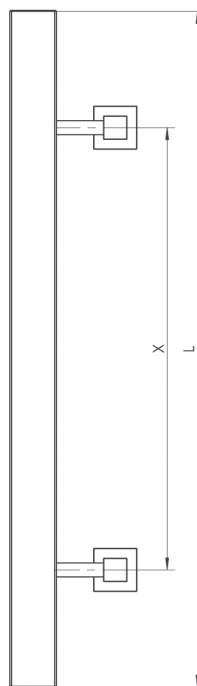
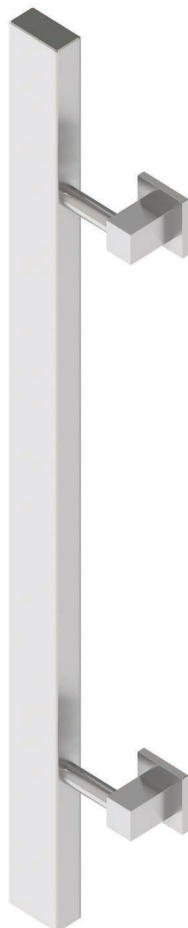

MATERIAŁ UCHWYTU		PROFIL UCHWYTU	KOD UCHWYTU	DŁUGOŚĆ L	ROZSTAW X	40x20		40x40	
STAL NIERDZEWNA 304	STAL NIERDZEWNA 316					304	316	304	316
 STAL NIERDZEWNA 304	 STAL NIERDZEWNA 316		Q5 L x X	150-580		●	●	○	○
POWIERZCHNIA STALI			Q5 L x X	581-1200		●	●	●	●
 SZLIFOWANA (DOMYŚLNA)	 PIASKOWANA		Q5 L x X	1201-2500	800-2300	○	○	●	●

✓ - produkt standardowy
 ● - produkt na specjalne, indywidualne zamówienie
 ○ - produkt niedostępny

Pochwyt Q5-FR

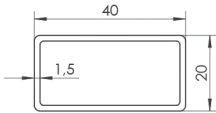

MATERIAŁ UCHWYTU		PROFIL UCHWYTU	KOD UCHWYTU	DŁUGOŚĆ L	ROZSTAW X	40x20	
POWIERZCHNIA STALI						304	316
 STAL NIERDZEWNA 304	 STAL NIERDZEWNA 316		Q5-FR L x X	150-580	max 380	●	●
 SZLIFOWANA (DOMYŚLNA)	 PIASKOWANA		Q5-FR L x X	581-1200	381-1000	●	●

- ✓ - produkt standardowy
- - produkt na specjalne, indywidualne zamówienie
- - produkt niedostępny

Pochwyty Q10

Elektronika*:

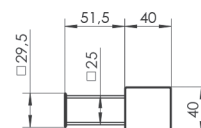
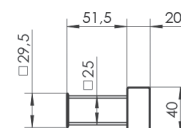
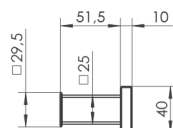
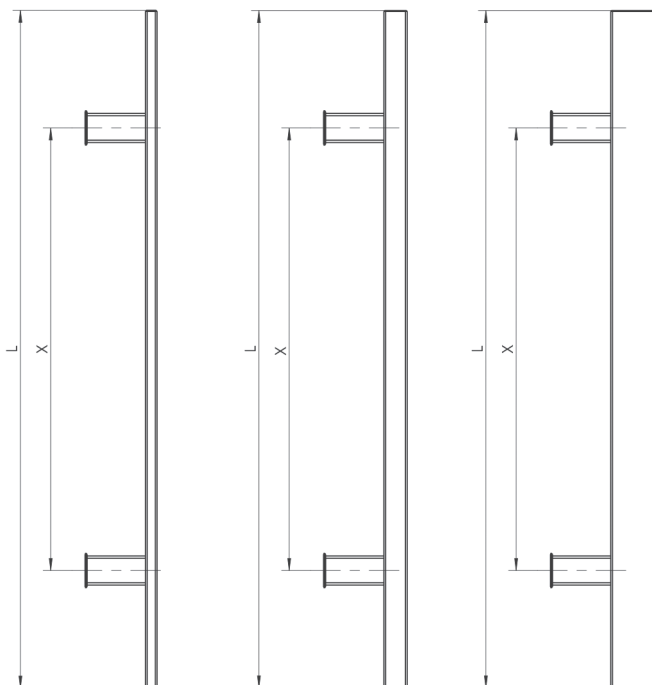
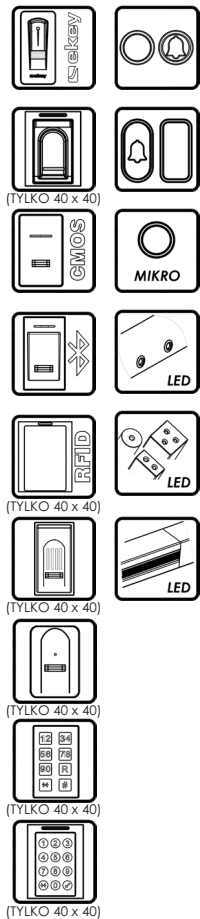

MATERIAŁ UCHWYTU

PROFIL UCHWYTU

KOD UCHWYTU	DŁUGOŚĆ L	ROZSTAW X	40x10 (*)		40x20		40x40	
			304	316	304	316	304	316
Q10 300 x 200	300	200	✓	●	✓	●	●	●
Q10 400 x 200	400	200	✓	●	✓	●	●	●
Q10 500 x 300	500	300	✓	✓	✓	✓	●	●
Q10 580 x 380	580	380	✓	✓	✓	✓	●	●
Q10 600 x 400	600	400	✓	✓	✓	✓	✓	●
Q10 800 x 600	800	600	✓	✓	✓	✓	✓	●
Q10 1000 x 800	1000	800	✓	✓	✓	✓	✓	●
Q10 1200 x 1000	1200	1000	✓	✓	✓	✓	✓	✓
Q10 1400 x 1200	1400	1200	○	○	✓	●	✓	●
Q10 1500 x 1300	1500	1300	○	○	✓	●	✓	●
Q10 1600 x 1300	1600	1300	○	○	✓	●	●	●
Q10 1600 x 1400	1600	1400	○	○	●	●	✓	✓
Q10 1800 x 1300	1800	1300	○	○	✓	○	●	●
Q10 1800 x 1600	1800	1600	○	○	○	○	✓	✓
Q10 2000 x 1800	2000	1800	○	○	○	○	✓	●
Q10 2200 x 2000	2200	2000	○	○	○	○	✓	●
Q10 L x X	150-1200		●	●	●	●	●	●
Q10 L x X	1201-2600	max 2300	○	○	○	○	●	●

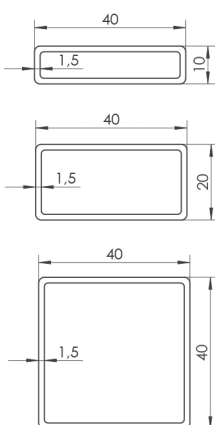

- ✓ - produkt standardowy
- - produkt na specjalne, indywidualne zamówienie
- - produkt niedostępny
- * - elektronika niedostępna w 40 x 10

Pochwyty QA10

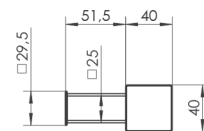
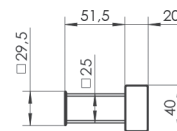
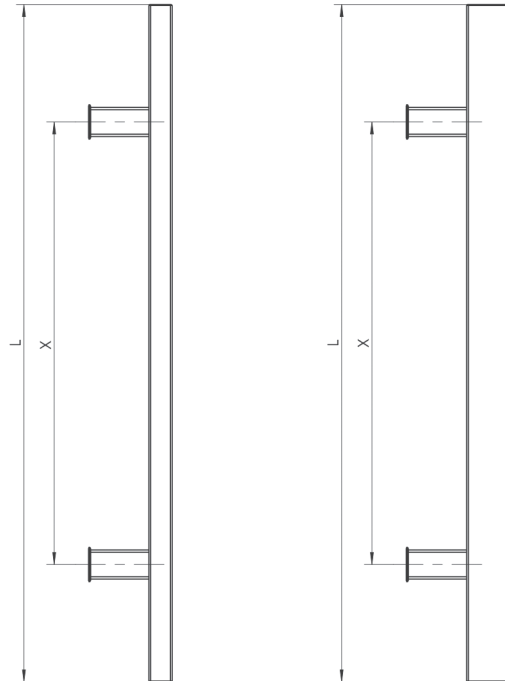
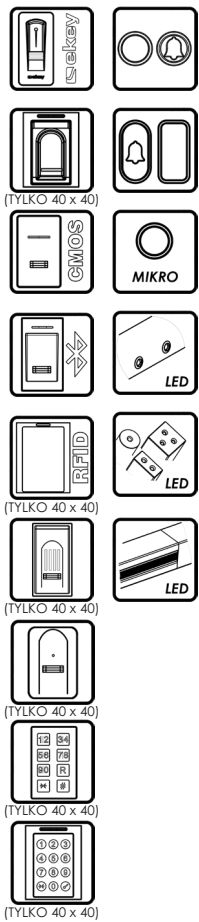

MATERIAŁ UCHWYTU	PROFIL UCHWYTU	KOD UCHWYTU	DŁUGOŚĆ L	ROZSTAW X	40x20	40x40
ALUMINIUM (możliwy lakier)		QA10 300 x 200	300	200	✓	●
		QA10 400 x 200	400	200	✓	●
		QA10 500 x 300	500	300	✓	●
		QA10 580 x 380	580	380	✓	●
		QA10 600 x 400	600	400	✓	●
		QA10 800 x 600	800	600	✓	✓
		QA10 1000 x 800	1000	800	✓	✓
		QA10 1200 x 1000	1200	1000	✓	✓
		QA10 1400 x 1200	1400	1200	✓	✓
		QA10 1600 x 1200	1600	1200	✓	✓
		QA10 1800 x 1300	1800	1300	●	✓
		QA10 2000 x 1600	2000	1600	●	✓
		QA10 L x X	150-1600		●	●
		QA10 L x X	1601-2300	max 1800	○	●
		QA10 L x X	2301-2600	3 punkty moc.	●	●



- ✓ - produkt standardowy
- - produkt na specjalne, indywidualne zamówienie
- - produkt niedostępny

Pochwyty Q10B

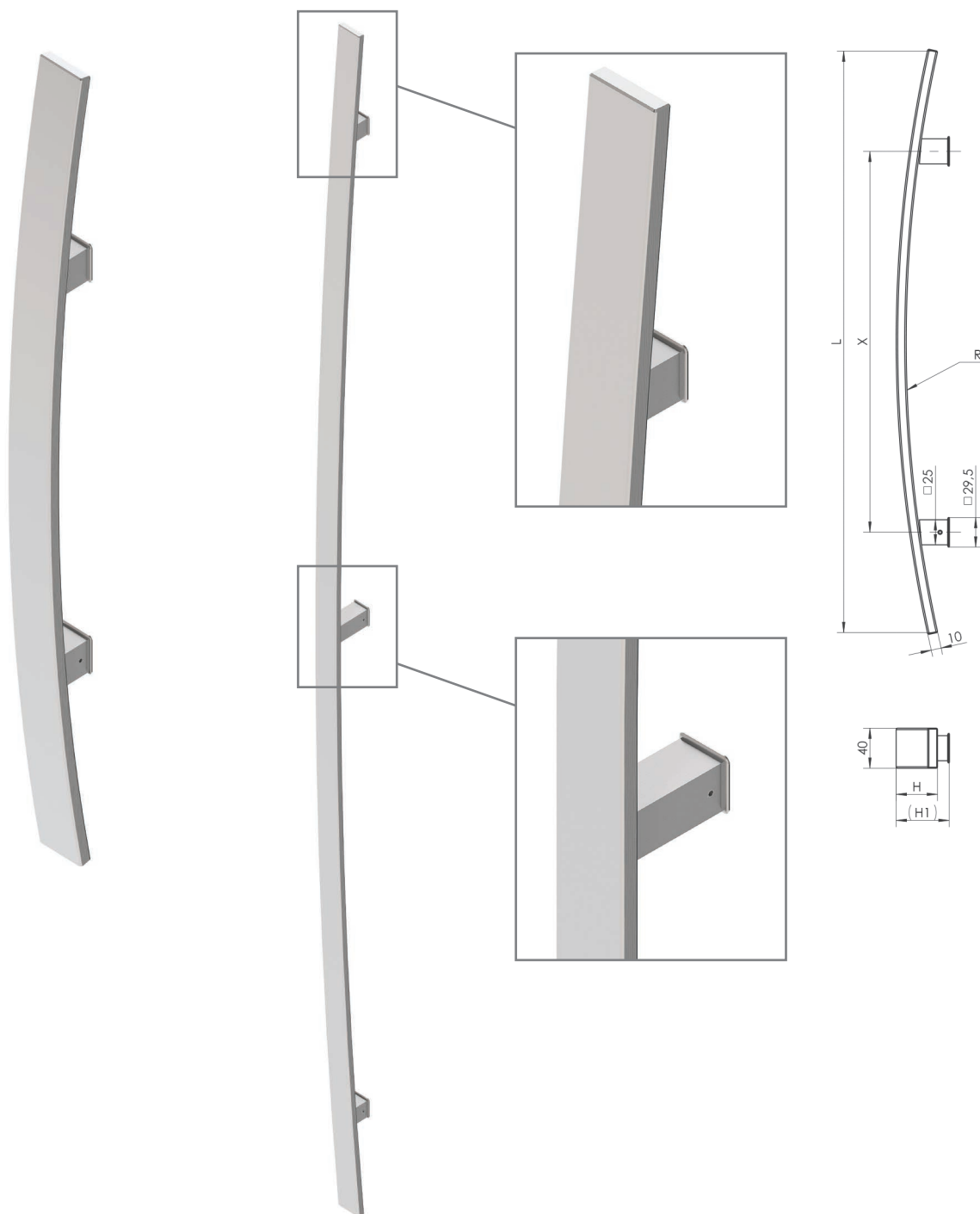

MATERIAŁ UCHWYTU		PROFIL UCHWYTU	KOD UCHWYTU	DŁUGOŚĆ L	ROZSTAW X	H	H1	R	40x10	
STAL NIERDZEWNA 304	STAL NIERDZEWNA 316								304	316
○	○		Q10B 600 x 300	600	300	40	46	1510	✓	✓
○	○		Q10B 1200 x 900	1200	900	46	59	5013	✓	✓
○	○		Q10B 1800 x 1500	1800	(1500)*	54	69	9221	✓	✓

POWIERZCHNIA STALI		
○	○	○
SZLIFOWANA (DOMYŚLNA)	POLEROWANA	PIASKOWANA (max 1000 mm)

- * - uchwyt z dodatkową trzecią nóżką na środku
- ✓ - produkt standardowy
- - produkt na specjalne, indywidualne zamówienie
- - produkt niedostępny

Pochwyty Q10D

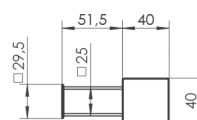
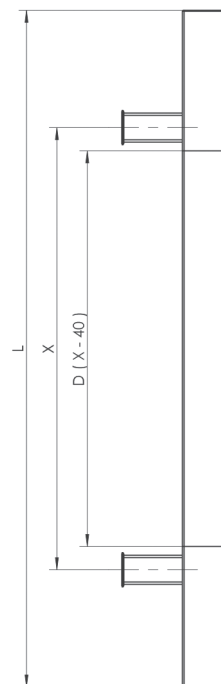
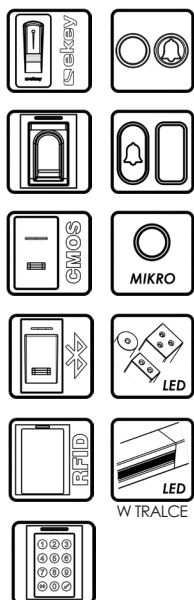

MATERIAŁ UCHWYTU			PROFIL UCHWYTU	KOD UCHWYTU	DŁUGOŚĆ L	ROZSTAW X	TRALKA D	40x40	
STAL NIERDZEWNA 304	STAL NIERDZEWNA 316	DĄB	304					316	
POWIERZCHNIA STALI SZLIFOWANA (DOMYŚLNA) POLEROWANA PIASKOWANA (max 1000 mm)				Q10D 1000 x 800	1000	800	760	✓	✓
				Q10D 1200 x 1000	1200	1000	960	✓	✓
				Q10D 1600 x 1400	1600	1400	1360	✓	✓

✓ - produkt standardowy
 ● - produkt na specjalne, indywidualne zamówienie
 ○ - produkt niedostępny
 * - możliwość zastosowania elektroniki tylko poza rozstawem chwyty w części metalowej uchwytu z pominięciem części drewnianej (z wyjątkiem taśmy LED)

Tralka uchwytu Q10D standard - wykonana jest z dębu pokryta bejcą Sopur 2245 złoty dąb oraz lakierem bezbarwnym. Można również zamówić tralkę surową, malowaną na czarno lub w kolorze bejcy Sopur: Ciemny orzech (brąz 22-50), Orzech (orzech 22-74), Palisander (palisander 26-01) pokryta lakierem bezbarwnym.

Pochwyty Q10RX

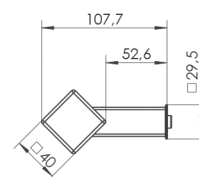
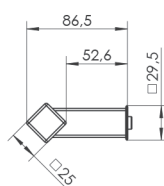
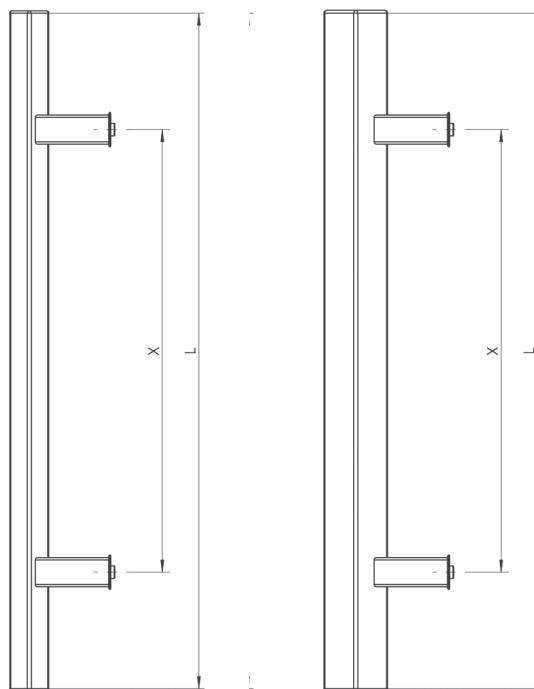
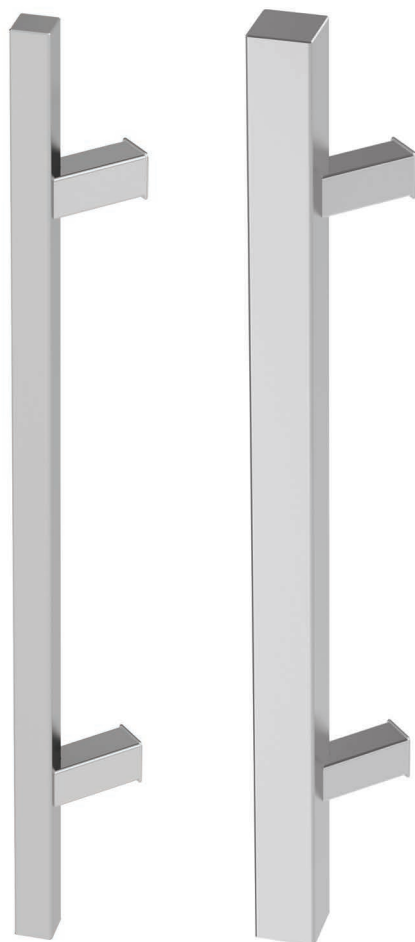







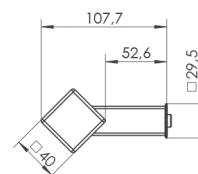
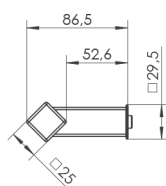
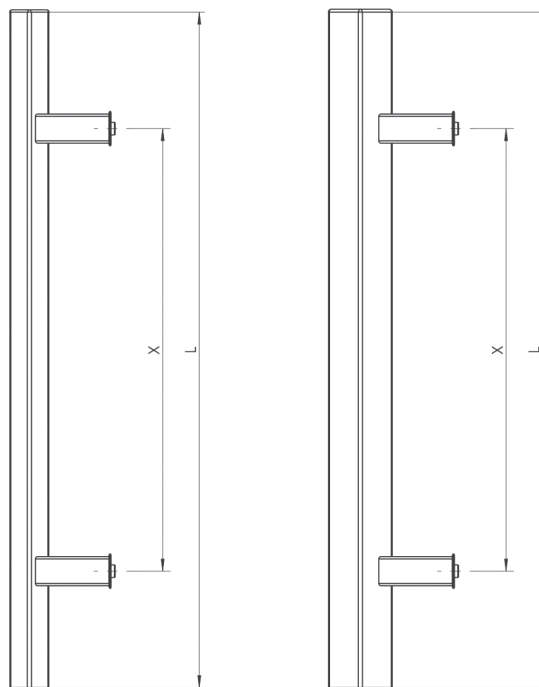

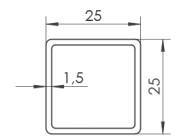
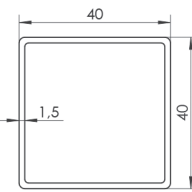



MATERIAŁ UCHWYTU		PROFIL UCHWYTU	KOD UCHWYTU	DŁUGOŚĆ L	ROZSTAW X	25x25		40x40	
STAL NIERDZEWNA 304	STAL NIERDZEWNA 316	POWIERZCHNIA STALI				304	316	304	316
			Q10RX 300 x 200	300	200	✓	●	●	●
			Q10RX 400 x 200	400	200	✓	●	●	●
			Q10RX 500 x 300	500	300	✓	✓	●	●
			Q10RX 580 x 380	580	380	✓	✓	●	●
			Q10RX 600 x 400	600	400	✓	✓	✓	●
			Q10RX 800 x 600	800	600	✓	✓	✓	●
			Q10RX 1000 x 800	1000	800	✓	✓	✓	●
			Q10RX 1200 x 1000	1200	1000	✓	✓	✓	✓
			Q10RX 1400 x 1200	1400	1200	✓	●	✓	●
			Q10RX 1500 x 1300	1500	1300	✓	●	✓	●
			Q10RX 1600 x 1300	1600	1300	✓	●	●	●
			Q10RX 1600 x 1400	1600	1400	●	●	✓	✓
			Q10RX 1800 x 1300	1800	1300	✓	●	●	●
			Q10RX 1800 x 1600	1800	1600	●	●	✓	✓
			Q10RX 2000 x 1800	2000	1800	●	●	✓	●
			Q10RX 2200 x 2000	2200	2000	○	○	✓	●
			Q10RX L x X	150-2000	max 1800	●	●	●	●
			Q10RX L x X	2001-2600	max 2300	○	○	●	●

- ✓ - produkt standardowy
- - produkt na specjalne, indywidualne zamówienie
- - produkt niedostępny

Pochwyty QA10RX







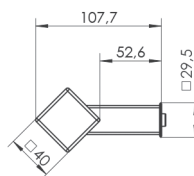
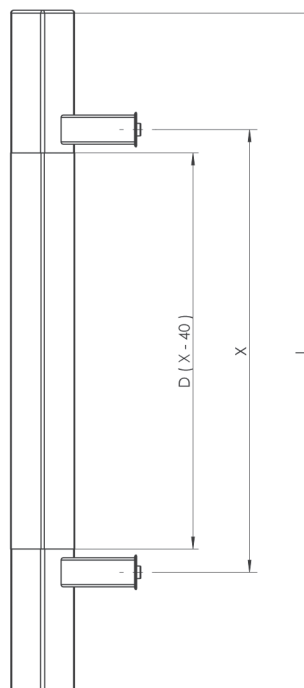

MATERIAŁ UCHWYTU		PROFIL UCHWYTU	KOD UCHWYTU	DŁUGOŚĆ L	ROZSTAW X	25x25	40x40	
 ALUMINIUM (możliwy lakier)		 	QA10RX 300 x 200	300	200	✓	●	
POWIERZCHNIA			QA10RX 400 x 200	400	200	✓	●	
				QA10RX 500 x 300	500	300	✓	●
CZARNY RAL 9005	BRAZOWY RAL 8077	BRAZOWY RAL 8019	BRAZOWY RAL 8017	QA10RX 580 x 380	580	380	✓	●
				QA10RX 600 x 400	600	400	✓	●
BRAZOWY RAL 8003	ZŁOTY W4 RAL 8003	ZŁOTY W3 RAL 8003	ANTRACYT RAL 7016	QA10RX 800 x 600	800	600	✓	✓
				QA10RX 1000 x 800	1000	800	✓	✓
BIAŁY RAL 9016	ANODA	NIETYPOWY RAL		QA10RX 1200 x 1000	1200	1000	✓	✓
✓	- produkt standardowy			QA10RX 1400 x 1200	1400	1200	○	✓
●	- produkt na specjalne, indywidualne zamówienie			QA10RX 1600 x 1200	1600	1200	○	✓
○	- produkt niedostępny			QA10RX 1800 x 1300	1800	1300	○	✓
				QA10RX 2000 x 1600	2000	1600	○	✓
				QA10RX L x X	150-1200		●	●
				QA10RX L x X	1201-2600		○	●

Dla uchwytów 40 x 40 o długości przekraczającej 2300 mm sugerujemy zastosować dodatkową trzecią nóżkę.

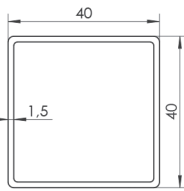
Pochwyty Q10RXD



MATERIAŁ UCHWYTU			PROFIL UCHWYTU	KOD UCHWYTU	DŁUGOŚĆ L	ROZSTAW X	40x40	
STAL NIERDZEWNA 304	STAL NIERDZEWNA 316	DĄB	304				316	
				Q10RXD 1000 x 800	1000	800	✓	✓
POWIERZCHNIA STALI				Q10RXD 1200 x 1000	1200	1000	✓	✓
				Q10RXD 1600 x 1400	1600	1400	✓	✓

✓ - produkt standardowy
 ● - produkt na specjalne, indywidualne zamówienie
 ○ - produkt niedostępny

Tralka uchwytu Q10RXD standard - wykonana jest z dębu pokryta bejcą Sopur 2245 złoty dąb oraz lakierem bezbarwnym. Można również zamówić tralkę surową, malowaną na czarno lub w kolorze bejcy Sopur: Ciemny orzech (brzq 22-50), Orzech (orzech 22-74), Palisander (palisander 26-01) pokryta lakierem bezbarwnym.

Pochwyty Q45

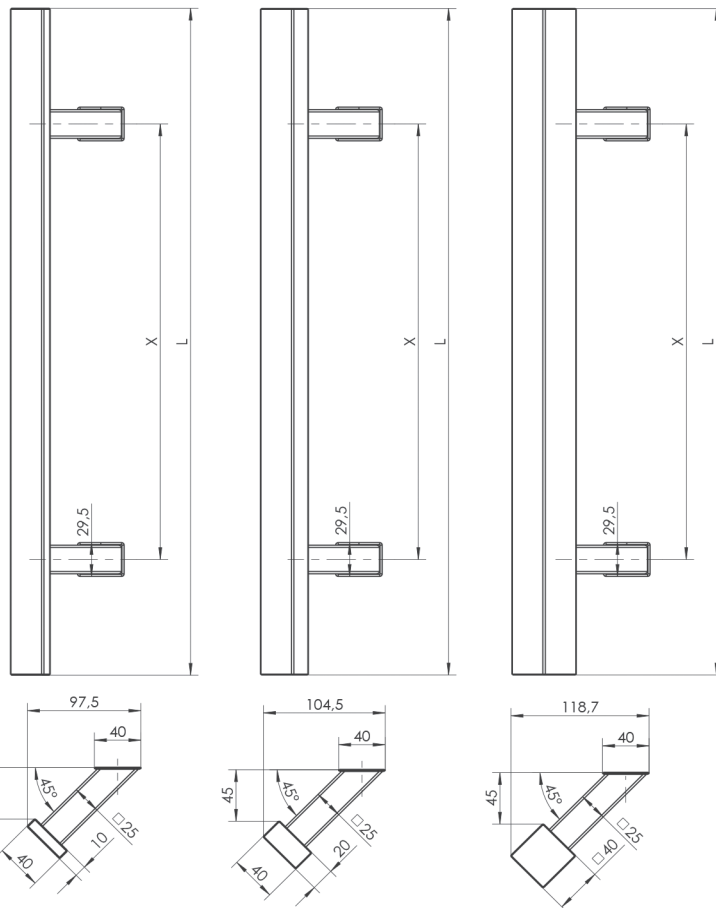
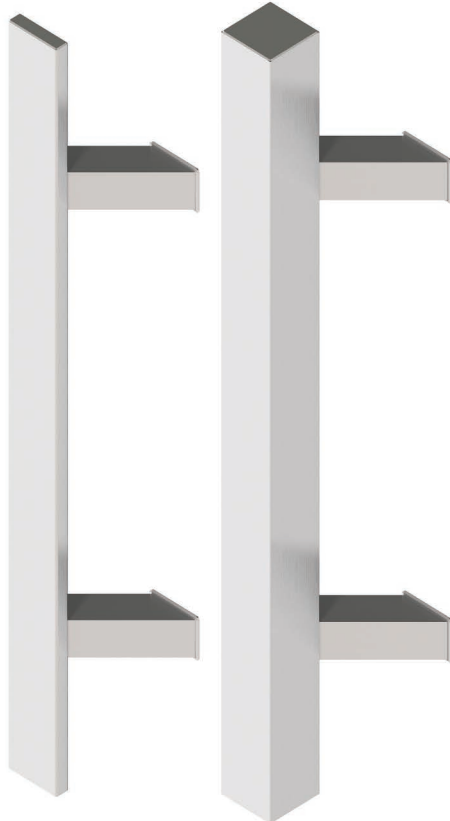
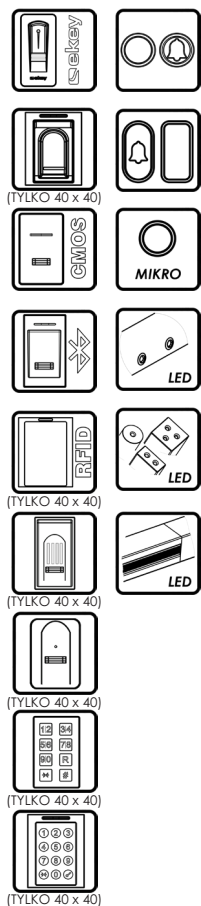







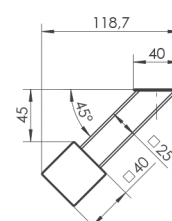
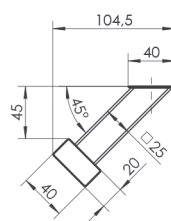
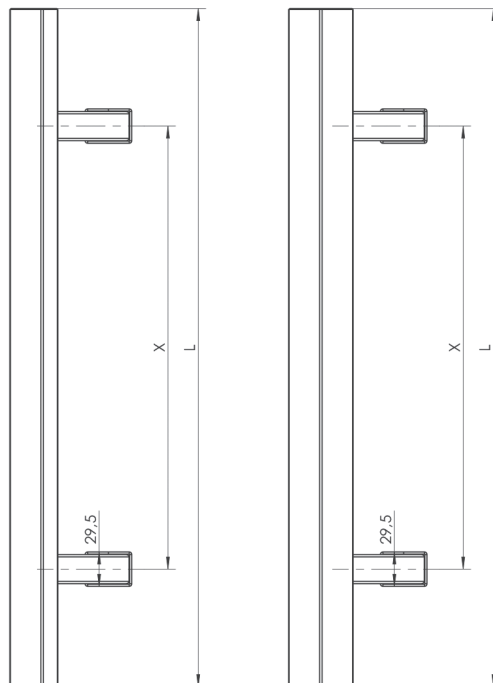
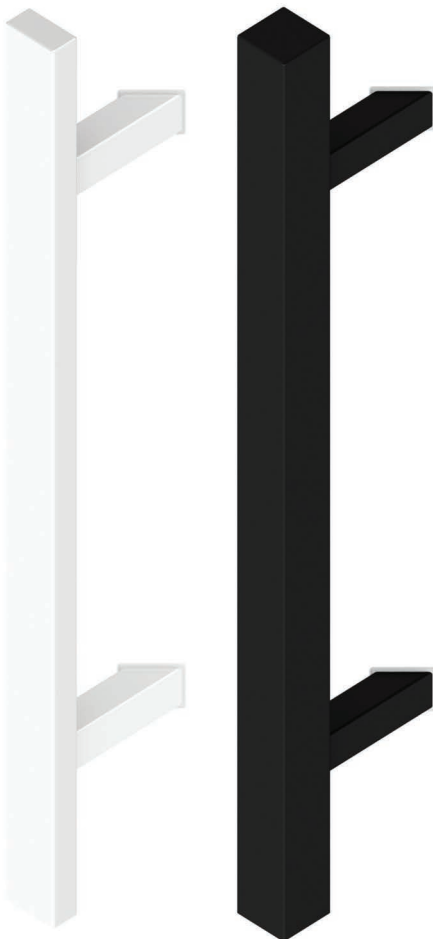
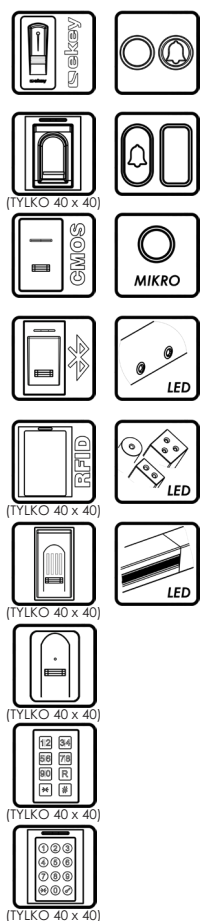

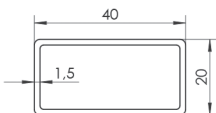
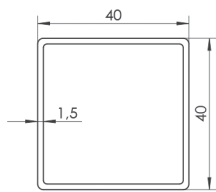



MATERIAŁ UCHWYTU		PROFIL UCHWYTU	KOD UCHWYTU	DŁUGOŚĆ L	ROZSTAW X	40x10 (*)		40x20		40x40	
STAL NIERDZEWNA 304	STAL NIERDZEWNA 316					304	316	304	316	304	316
			Q45 300 x 200	300	200	✓	●	✓	●	●	●
			Q45 400 x 200	400	200	✓	●	✓	●	●	●
			Q45 500 x 300	500	300	✓	✓	✓	✓	●	●
			Q45 580 x 380	580	380	✓	✓	✓	✓	●	●
			Q45 600 x 400	600	400	✓	✓	✓	✓	✓	●
			Q45 800 x 600	800	600	✓	✓	✓	✓	✓	●
			Q45 1000 x 800	1000	800	✓	✓	✓	✓	✓	●
			Q45 1200 x 1000	1200	1000	✓	✓	✓	✓	✓	✓
			Q45 1400 x 1200	1400	1200	○	○	✓	●	✓	●
			Q45 1500 x 1300	1500	1300	○	○	✓	●	✓	●
			Q45 1600 x 1300	1600	1300	○	○	✓	●	●	●
			Q45 1600 x 1400	1600	1400	○	○	●	●	✓	✓
			Q45 1800 x 1300	1800	1300	○	○	✓	●	●	●
			Q45 1800 x 1600	1800	1600	○	○	○	○	✓	✓
			Q45 2000 x 1800	2000	1800	○	○	○	○	✓	●
			Q45 2200 x 2000	2200	2000	○	○	○	○	✓	●
			Q45 L x X	150-1200		●	●	●	●	●	●
			Q45 L x X	1201-2000	max 1800	○	○	●	●	●	●
			Q45 L x X	2001-2600	max 2300	○	○	○	○	●	●

- ✓ - produkt standardowy
- - produkt na specjalne, indywidualne zamówienie
- - produkt niedostępny
- * - elektronika niedostępna w 40 x 10

Pochwyty QA45



MATERIAŁ UCHWYTU		PROFIL UCHWYTU		KOD UCHWYTU	DŁUGOŚĆ L	ROZSTAW X	40x20	40x40
 ALUMINIUM (możliwy lakier)				QA45 300 x 200	300	200	✓	●
POWIERZCHNIA				QA45 400 x 200	400	200	✓	●
				QA45 500 x 300	500	300	✓	●
CZARNY RAL 9005	BRAZOWY RAL 8077	BRAZOWY RAL 8019	BRAZOWY RAL 8017	QA45 580 x 380	580	380	✓	●
				QA45 600 x 400	600	400	✓	●
BRAZOWY RAL 8003	ZŁOTY W4	ZŁOTY W3	ANTRACYT RAL 7016	QA45 800 x 600	800	600	✓	✓
				QA45 1000 x 800	1000	800	✓	✓
BIAŁY RAL 9016	ANODA	NIETYPOWY RAL		QA45 1200 x 1000	1200	1000	✓	✓
				QA45 1400 x 1200	1400	1200	✓	✓
				QA45 1600 x 1200	1600	1200	✓	✓
				QA45 1800 x 1300	1800	1300	●	✓
				QA45 2000 x 1600	2000	1600	●	✓
				QA45 L x X	150-1600	max 1200	●	●
				QA45 L x X	1601-2300	max 1800	○	●
				QA45 L x X	2301-2600	3 punkty moc.	●	●

- ✓ - produkt standardowy
- - produkt na specjalne, indywidualne zamówienie
- - produkt niedostępny

Pochwyt Q45D

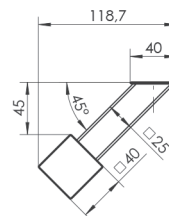
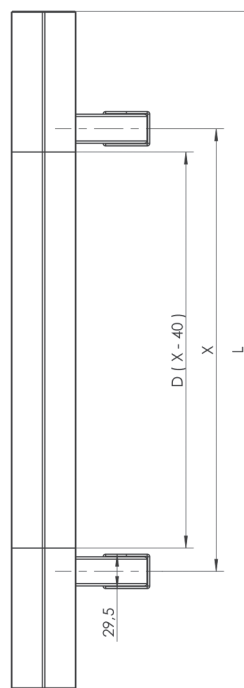
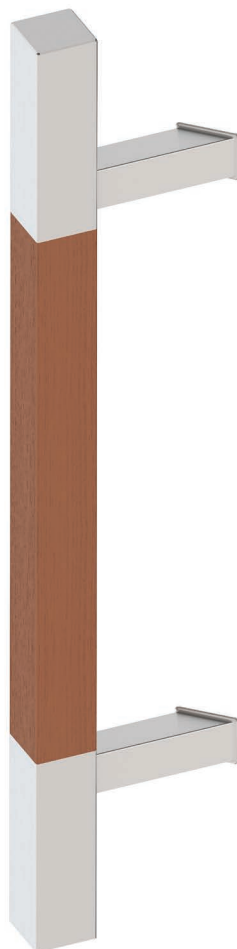
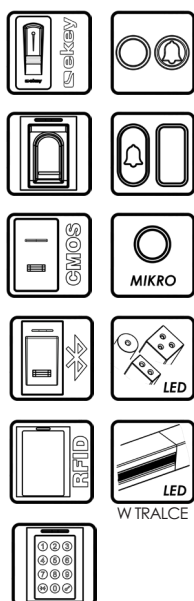

MATERIAŁ UCHWYTU			PROFIL UCHWYTU		KOD UCHWYTU	DŁUGOŚĆ L	ROZSTAW X	TRALKA D	40x40	
STAL NIERDZEWNA 304	STAL NIERDZEWNA 316	DAŁB	40	40					304	316
 STAL NIERDZEWNA 304	 STAL NIERDZEWNA 316	 DAŁB			Q45D 1000 x 800	1000	800	760	✓	✓
POWIERZCHNIA STALI					Q45D 1200 x 1000	1200	1000	960	✓	✓
 SZLIFOWANA (DOMYŚLNA)	 POLEROWANA	 PIASKOWANA (max 1000 mm)	✓ - produkt standardowy ● - produkt na specjalne, indywidualne zamówienie ○ - produkt niedostępny * - możliwość zastosowania elektroniki tylko poza rozstawem chwytu w części metalowej uchwytu z pominięciem części drewnianej (z wyjątkiem taśmy LED)							
			Q45D 1600 x 1400	1600	1400	1360	✓	✓		

Tralka uchwytu Q45D standard - wykonana jest z dębu pokryta bejcą Sopur 2245 złoty dąb oraz lakierem bezbarwnym. Można również zamówić tralkę surową, malowaną na czarno lub w kolorze bejcy Sopur: Ciemny orzech (brąz 22-50), Orzech (orzech 22-74), Palisander (palisander 26-01) pokryta lakierem bezbarwnym.

Pochwyt Q45RX

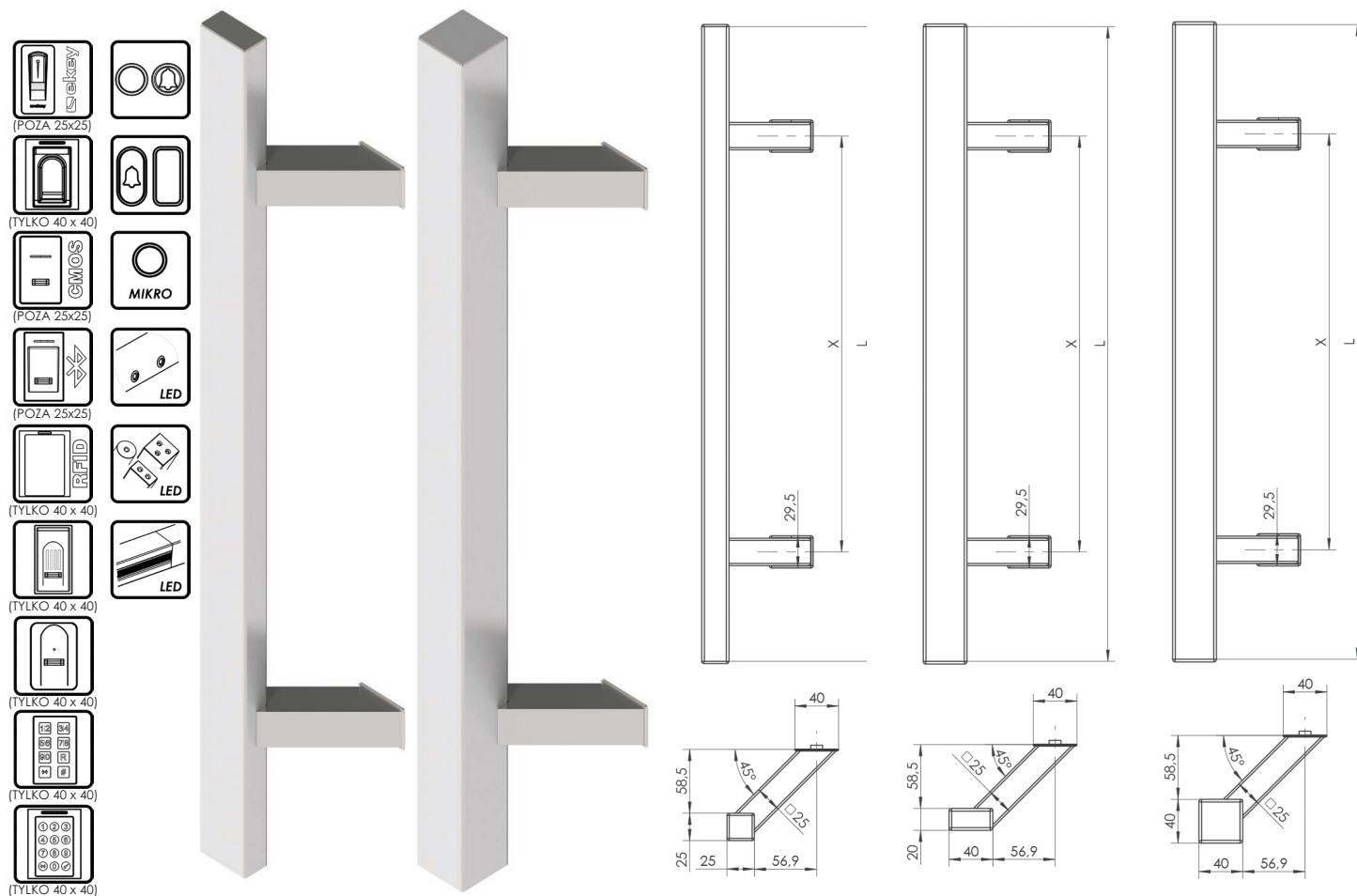

MATERIAŁ UCHWYTU		PROFIL UCHWYTU	KOD UCHWYTU	DŁUGOŚĆ L	ROZSTAW X	25x25		40x20		40x40	
STAL NIERDZEWNA 304	STAL NIERDZEWNA 316	304				316	304	316	304	316	
			Q45RX 300 x 200	300	200	✓	●	✓	●	●	●
			Q45RX 400 x 200	400	200	✓	●	✓	●	●	●
			Q45RX 500 x 300	500	300	✓	✓	✓	✓	●	●
			Q45RX 580 x 380	580	380	✓	✓	✓	✓	●	●
			Q45RX 600 x 400	600	400	✓	✓	✓	✓	✓	●
			Q45RX 800 x 600	800	600	✓	✓	✓	✓	✓	●
			Q45RX 1000 x 800	1000	800	✓	✓	✓	✓	✓	●
			Q45RX 1200 x 1000	1200	1000	✓	✓	✓	✓	✓	✓
			Q45RX 1400 x 1200	1400	1200	✓	●	✓	●	✓	●
			Q45RX 1500 x 1300	1500	1300	✓	●	✓	●	✓	●
			Q45RX 1600 x 1300	1600	1300	✓	●	✓	●	●	●
			Q45RX 1600 x 1400	1600	1400	●	●	●	●	✓	✓
			Q45RX 1800 x 1300	1800	1300	✓	●	✓	●	●	●
			Q45RX 1800 x 1600	1800	1600	●	●	●	●	✓	✓
			Q45RX 2000 x 1800	2000	1800	●	●	●	●	✓	●
			Q45RX 2200 x 2000	2200	2000	○	○	○	○	✓	●
			Q45RX L x X	150-2000		●	●	●	●	●	●
			Q45RX L x X	2001-2600	max 2300	○	○	○	○	●	●

- ✓ - produkt standardowy
- - produkt na specjalne, indywidualne zamówienie
- - produkt niedostępny

Pochwyty QA45RX

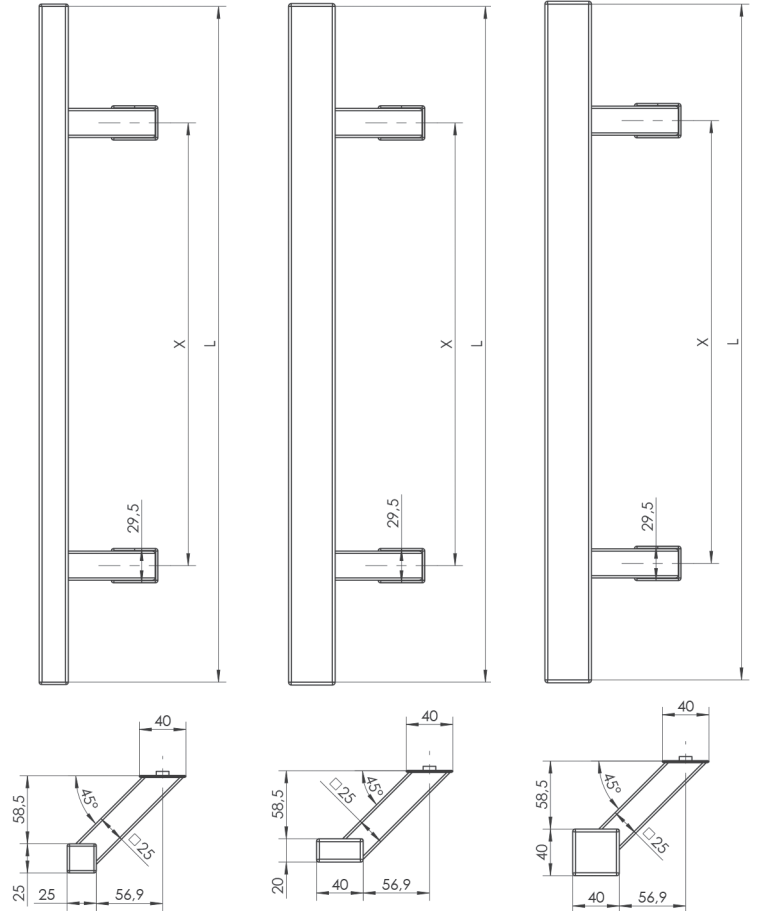
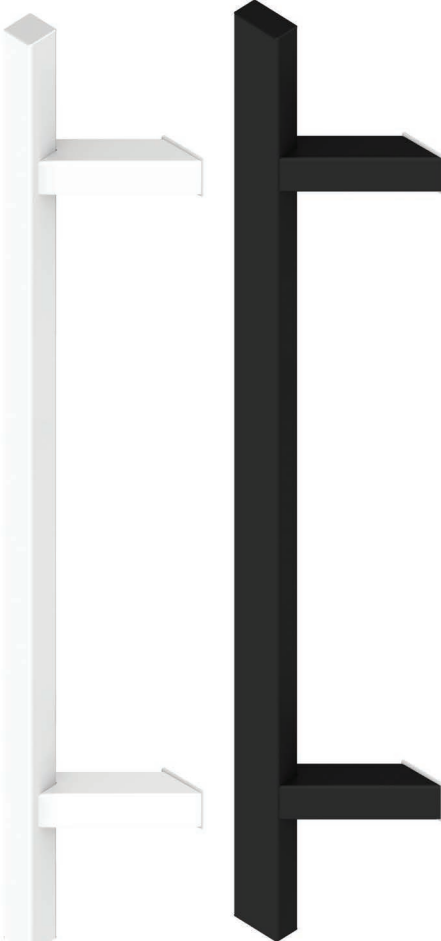
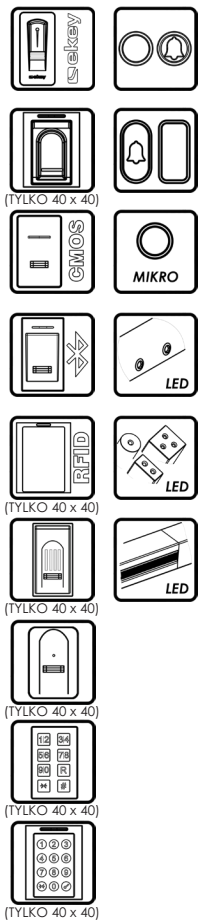

MATERIAŁ UCHWYTU		PROFIL UCHWYTU	KOD UCHWYTU	DŁUGOŚĆ L	ROZSTAW X	25x25	40x20	40x40
ALUMINIUM (możliwy lakier)			QA45RX 300 x 200	300	200	✓	✓	●
POWIERZCHNIA			QA45RX 400 x 200	400	200	✓	✓	●
			QA45RX 500 x 300	500	300	✓	✓	●
CZARNY RAL 9005	BRAŻOWY RAL 8077		QA45RX 580 x 380	580	380	✓	✓	●
			QA45RX 600 x 400	600	400	✓	✓	●
BRAŻOWY RAL 8003	ZŁOTY W4		QA45RX 800 x 600	800	600	✓	✓	✓
			QA45RX 1000 x 800	1000	800	✓	✓	✓
	ZŁOTY W3		QA45RX 1200 x 1000	1200	1000	✓	✓	✓
	ANTRACYT RAL 7016		QA45RX 1400 x 1200	1400	1200	●	✓	✓
			QA45RX 1600 x 1200	1600	1200	●	✓	✓
BIAŁY RAL 9016	ANODA		QA45RX 1800 x 1300	1800	1300	●	●	✓
	NIETYPOWY RAL		QA45RX 2000 x 1600	2000	1600	●	●	✓
			QA45RX L x X	150 - 1200		●	●	●
			QA45RX L x X	1201 - 1600	max 1200	○	●	●
			QA45RX L x X	1601 - 2300	max 1800	○	○	●
			QA45RX L x X	2301 - 2600	3 punkty moc.	○	●	●

- ✓ - produkt standardowy
- - produkt na specjalne, indywidualne zamówienie
- - produkt niedostępny

Pochwyty Q45RXD

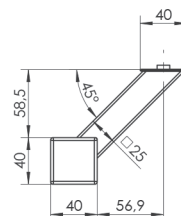
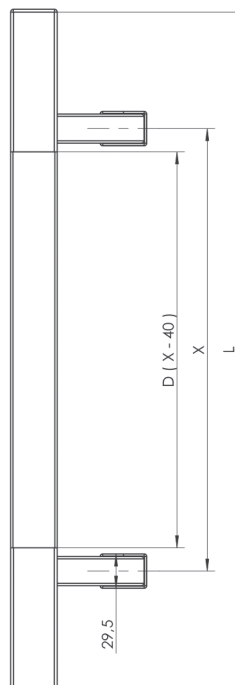
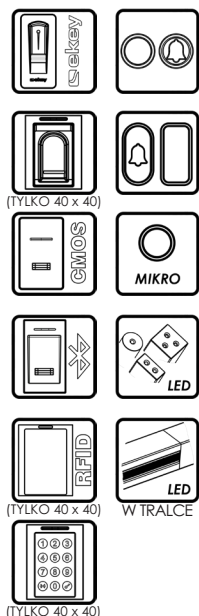

MATERIAŁ UCHWYTU			PROFIL UCHWYTU		KOD UCHWYTU	DŁUGOŚĆ L	ROZSTAW X	40x40	
304	316	DĄB	40	40				304	316
STAL NIERDZEWNA 304	STAL NIERDZEWNA 316	DĄB	40	40	Q45RXD 1000 x 800	1000	800	✓	✓
POWIERZCHNIA STALI			1.5	40	Q45RXD 1200 x 1000	1200	1000	✓	✓
					Q45RXD 1600 x 1400	1600	1400	✓	✓



- ✓ - produkt standardowy
- - produkt na specjalne, indywidualne zamówienie
- - produkt niedostępny
- * - możliwość zastosowania elektroniki tylko poza rozstawem chwyty w części metalowej uchwytu z pominięciem części drewnianej (z wyjątkiem taśmy LED)

Tralka uchwytu Q45RXD standard - wykonana jest z dębu pokryta bejccą Sopur 2245 złoty dąb oraz lakierem bezbarwnym. Można również zamówić tralkę surową, malowaną na czarno lub w kolorze bejcy Sopur: Ciemny orzech (brz 22-50), Orzech (orzech 22-74), Palisander (palisander 26-01) pokryta lakierem bezbarwnym.

Pochwyty Q60

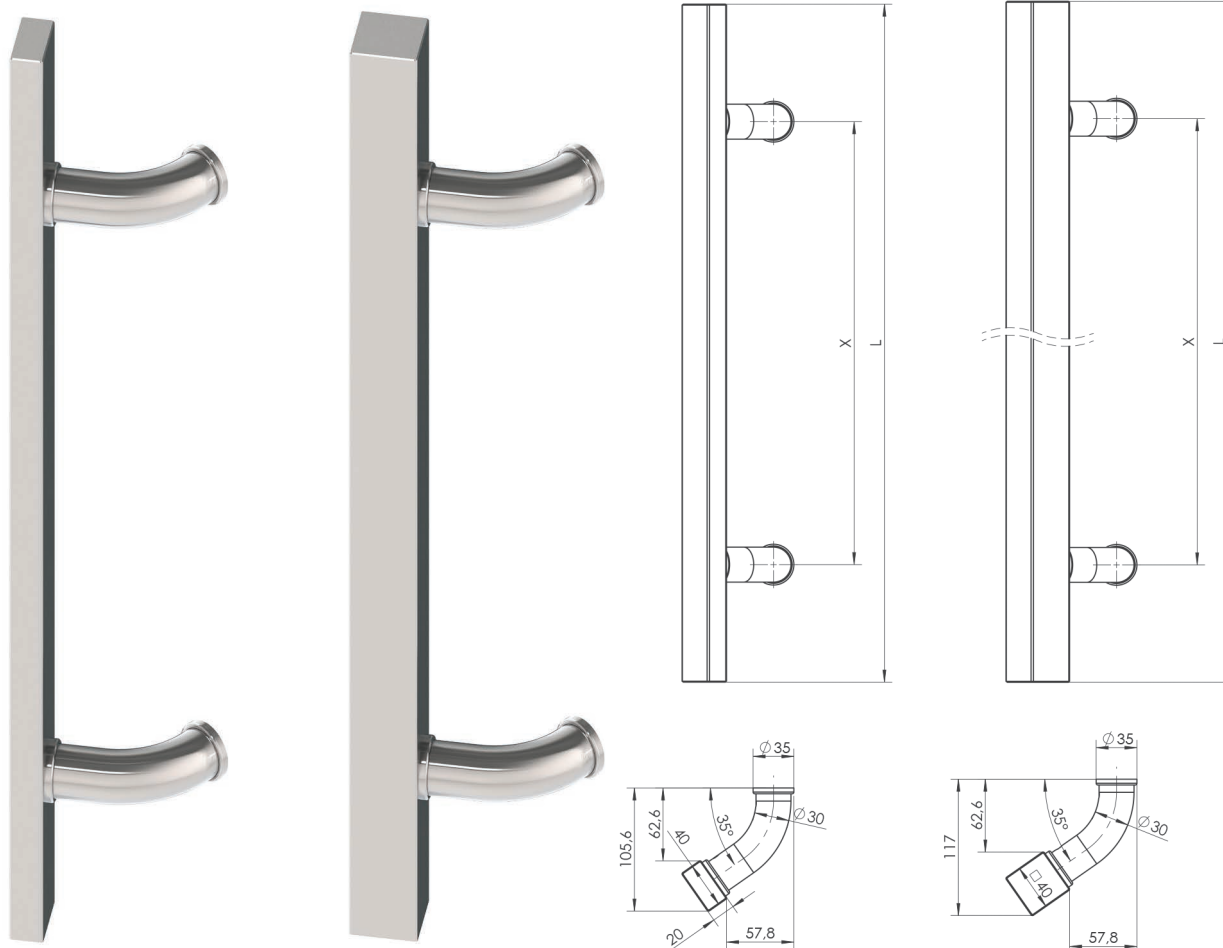

MATERIAŁ UCHWYTU		PROFIL UCHWYTU	KOD UCHWYTU	DŁUGOŚĆ L	ROZSTAW X	40x20		40x40	
POWIERZCHNIA STALI						304	316	304	316
 STAL NIERDZEWNA 304	 STAL NIERDZEWNA 316	 40 1.5 20	Q60 580 x 380	580	380	✓	✓	●	●
		 40 1.5 40	Q60 800 x 600	800	600	✓	✓	●	●
			Q60 L x X	150-1200		●	●	●	●
			Q60 L x X	1201-2500	800-2300	○	○	●	●

✓ - produkt standardowy
 ● - produkt na specjalne, indywidualne zamówienie
 ○ - produkt niedostępny

Pochwyt Q90

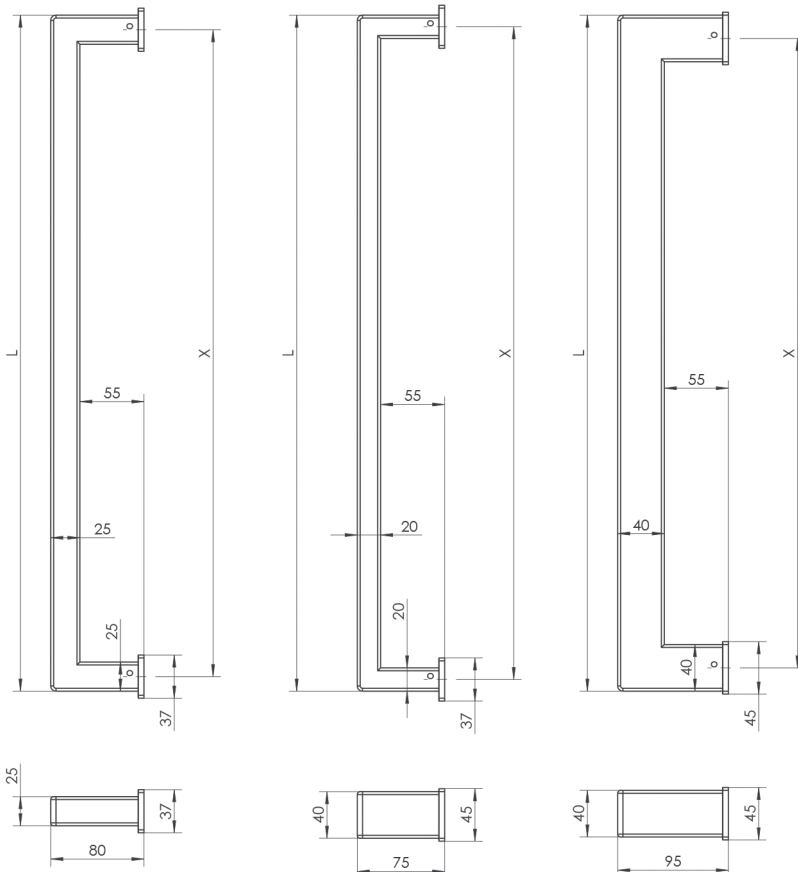

MATERIAŁ UCHWYTU		PROFIL UCHWYTU	KOD UCHWYTU	DŁUGOŚĆ L	ROZSTAW X			25x25		40x20		40x40	
STAL NIERDZEWNA 304	STAL NIERDZEWNA 316				25x25	40x20	40x40	304	316	304	316	304	316
			Q90 300	300	275	280	260	✓	✓	✓	✓	●	●
			Q90 400	400	375	380	360	✓	✓	✓	✓	●	●
			Q90 500	500	475	480	460	✓	✓	✓	✓	●	●
			Q90 580	580	555	560	540	✓	✓	✓	✓	●	●
			Q90 600	600	575	580	560	✓	✓	✓	✓	✓	✓
			Q90 800	800	775	780	760	✓	✓	✓	✓	✓	✓
			Q90 1000	1000	975	980	960	✓	✓	✓	✓	✓	✓
			Q90 1200	1200	1175	1180	1160	✓	✓	✓	✓	✓	✓
			Q90 1400	1400	1375	1380	1360	○	○	○	○	✓	✓
			Q90 1600	1600	1575	1580	1560	○	○	○	○	✓	✓
			Q90 1800	1800	1775	1780	1760	○	○	○	○	✓	✓
			Q90 2000	2000	1975	1980	1960	○	○	○	○	✓	✓
			Q90 2200	2200	2175	2180	2160	○	○	○	○	✓	✓
			Q90 L x X	300-1200	L-25	L-20	L-40	●	●	●	●	●	●
			Q90 L x X	1201-2500	L-25	L-20	L-40	○	○	○	○	●	●

- ✓ - produkt standardowy
- - produkt na specjalne, indywidualne zamówienie
- - produkt niedostępny

Pochwyt QA90

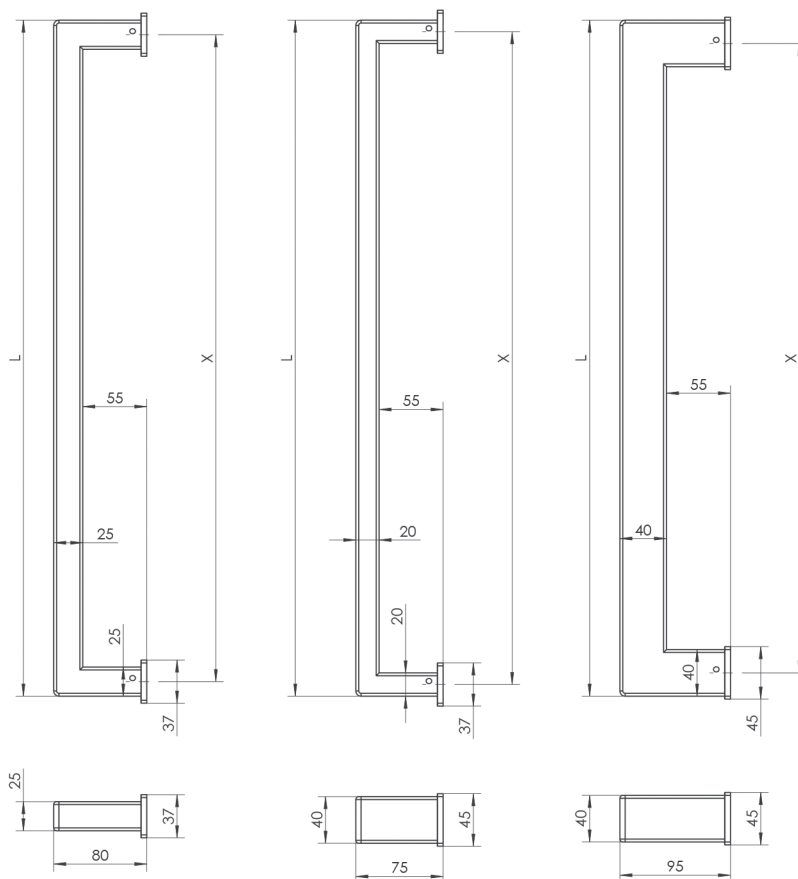
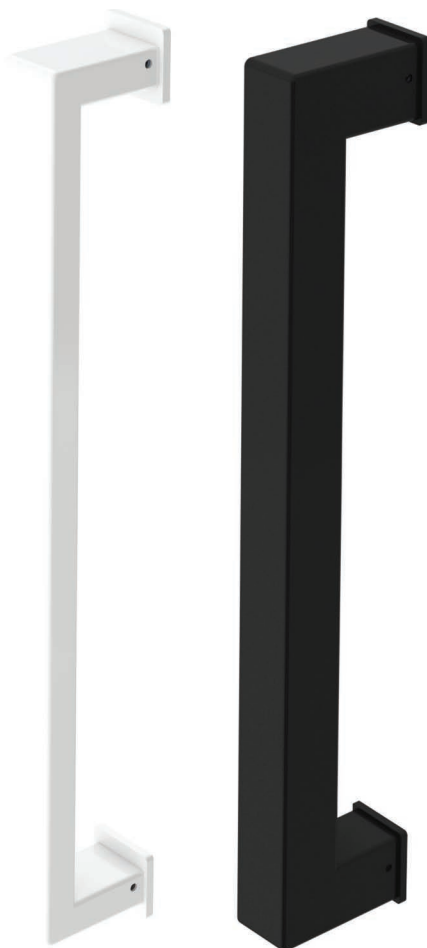

MATERIAŁ UCHWYTU	PROFIL UCHWYTU	KOD UCHWYTU	DŁUGOŚĆ L	ROZSTAW X			25x25	40x20	40x40
				25x25	40x20	40x40			
<p>ALUMINIUM (możliwy lakier)</p> <p>POWIERZCHNIA</p> <p>CZARNY RAL 9005 BRĄZOWY RAL 8077 BRĄZOWY RAL 8019 BRĄZOWY RAL 8017</p> <p>BRĄZOWY RAL 8003 ŻŁOTY W4 ŻŁOTY W3 ANTRACYT RAL 7016</p> <p>BIAŁY RAL 9016 NIETYPOWY RAL</p>		QA90 300	300	275	280	260	✓	✓	●
		QA90 400	400	375	380	360	✓	✓	●
		QA90 500	500	475	480	460	✓	✓	●
		QA90 580	580	555	560	540	✓	✓	●
		QA90 600	600	575	580	560	✓	✓	✓
		QA90 800	800	775	780	760	✓	✓	✓
		QA90 1000	1000	975	980	960	✓	✓	✓
		QA90 1200	1200	1175	1180	1160	✓	✓	✓
		QA90 1400	1400	1375	1380	1360	○	○	✓
		QA90 1600	1600	1575	1580	1560	○	○	✓
		QA90 1800	1800	1775	1780	1760	○	○	✓
		QA90 2000	2000	1975	1980	1960	○	○	✓
		QA90 2200	2200	2175	2180	2160	○	○	✓
		QA90 L x X	300-1200	L-25	L-20	L-40	●	●	●
QA90 L x X	1201-2300	L-25	L-20	L-40	○	○	●		

- ✓ - produkt standardowy
- - produkt na specjalne, indywidualne zamówienie
- - produkt niedostępny

Pochwyt Q90D

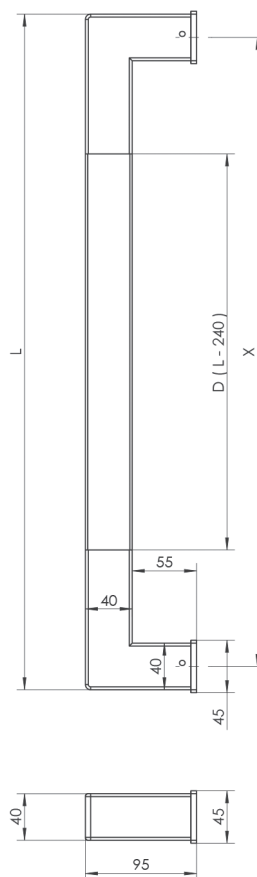

MATERIAŁ UCHWYTU	PROFIL UCHWYTU	KOD UCHWYTU	DŁUGOŚĆ L	ROZSTAW X	40x40	
					304	316
STAL NIERDZEWNA 304 STAL NIERDZEWNA 316 DĄB		Q90D 800	800	760	✓	✓
		Q90D 1000	1000	960	✓	✓
		Q90D 1200	1200	1160	✓	✓
		Q90D 1600	1600	1560	✓	✓

- ✓ - produkt standardowy
- - produkt na specjalne, indywidualne zamówienie
- - produkt niedostępny
- * - możliwość zastosowania elektroniki tylko poza rozstawem chwyty w części metalowej uchwytu z pominięciem części drewnianej (z wyjątkiem taśmy LED)

Tralka uchwytu Q90D standard - wykonana jest z dębu pokryta bejcą Sopur 2245 złoty dąb oraz lakierem bezbarwnym. Można również zamówić tralkę surową, malowaną na czarno lub w kolorze bejcy Sopur: Ciemny orzech (brąz 22-50), Orzech (orzech 22-74), Palisander (palisander 26-01) pokryta lakierem bezbarwnym.

Pochwyty QA90D

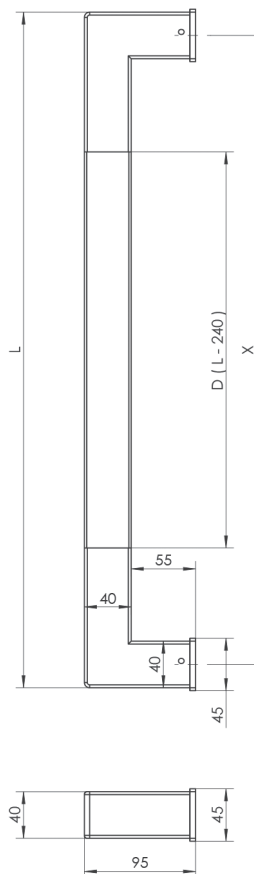

MATERIAŁ UCHWYTU	PROFIL UCHWYTU	KOD UCHWYTU	DŁUGOŚĆ L	ROZSTAW X	40x40
ALUMINIUM (możliwy lakier)		QA90D 800	800	760	✓
DĄB		QA90D 1000	1000	960	✓
POWIERZCHNIA		QA90D 1200	1200	1160	✓
		QA90D 1600	1600	1560	✓

- ✓ - produkt standardowy
- - produkt na specjalne, indywidualne zamówienie
- - produkt niedostępny
- * - możliwość zastosowania elektroniki tylko poza rozstawem chwytu w części metalowej uchwytu z pominięciem części drewnianej (z wyjątkiem taśmy LED)



Tralka uchwytu QA90D standard - wykonana jest z dębu pokryta bejcą Sopur 2245 złoty dąb oraz lakierem bezbarwnym. Można również zamówić tralkę surową, malowaną na czarno lub w kolorze bejcy Sopur: Ciemny orzech (brz 22-50), Orzech (orzech 22-74), Palisander (palisander 26-01) pokryta lakierem bezbarwnym.

Pochwyty Q90C

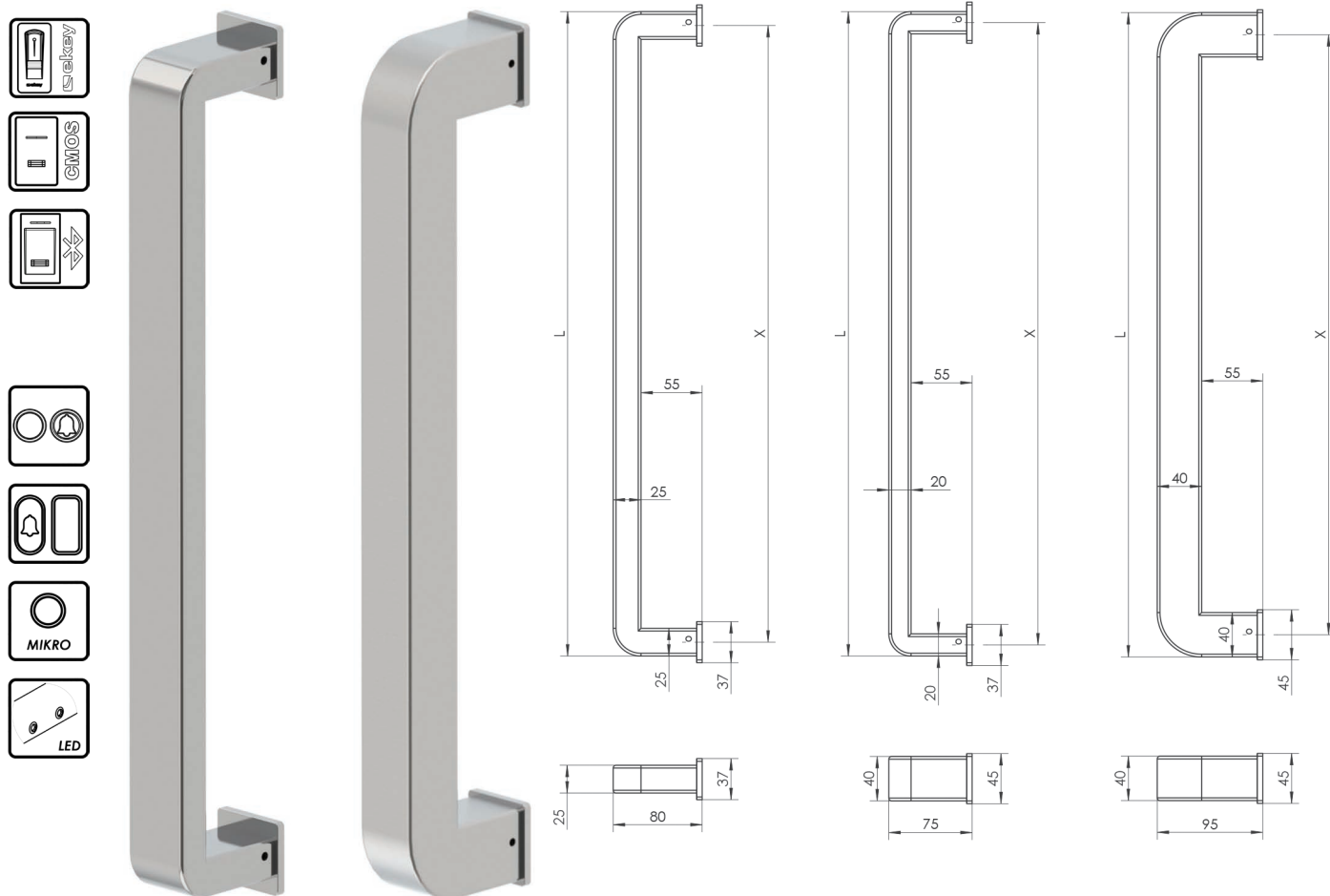

MATERIAŁ UCHWYTU		PROFIL UCHWYTU	KOD UCHWYTU	DŁUGOŚĆ L	ROZSTAW X			25x25		40x20		40x40	
STAL NIERDZEWNA 304	STAL NIERDZEWNA 316				25x25	40x20	40x40	304	316	304	316	304	316
			Q90C 300	300	275	280	260	✓	✓	✓	✓	●	●
			Q90C 400	400	375	380	360	✓	✓	✓	✓	●	●
			Q90C 500	500	475	480	460	✓	✓	✓	✓	●	●
			Q90C 580	580	555	560	540	✓	✓	✓	✓	●	●
			Q90C 600	600	575	580	560	✓	✓	✓	✓	✓	✓
			Q90C 800	800	775	780	760	✓	✓	✓	✓	✓	✓
			Q90C 1000	1000	975	980	960	✓	✓	✓	✓	✓	✓
			Q90C 1200	1200	1175	1180	1160	✓	✓	✓	✓	✓	✓
			Q90C 1400	1400	1375	1380	1360	○	○	○	○	✓	✓
			Q90C 1600	1600	1575	1580	1560	○	○	○	○	✓	✓
			Q90C 1800	1800	1775	1780	1760	○	○	○	○	✓	✓
			Q90C 2000	2000	1975	1980	1960	○	○	○	○	✓	✓
			Q90C 2200	2200	2175	2180	2160	○	○	○	○	✓	✓
			Q90C L x X	300-1200	L-25	L-20	L-40	●	●	●	●	●	●
			Q90C L x X	1201-2500	L-25	L-20	L-40	○	○	○	○	●	●

- ✓ - produkt standardowy
- - produkt na specjalne, indywidualne zamówienie
- - produkt niedostępny

Pochwyty QA90C

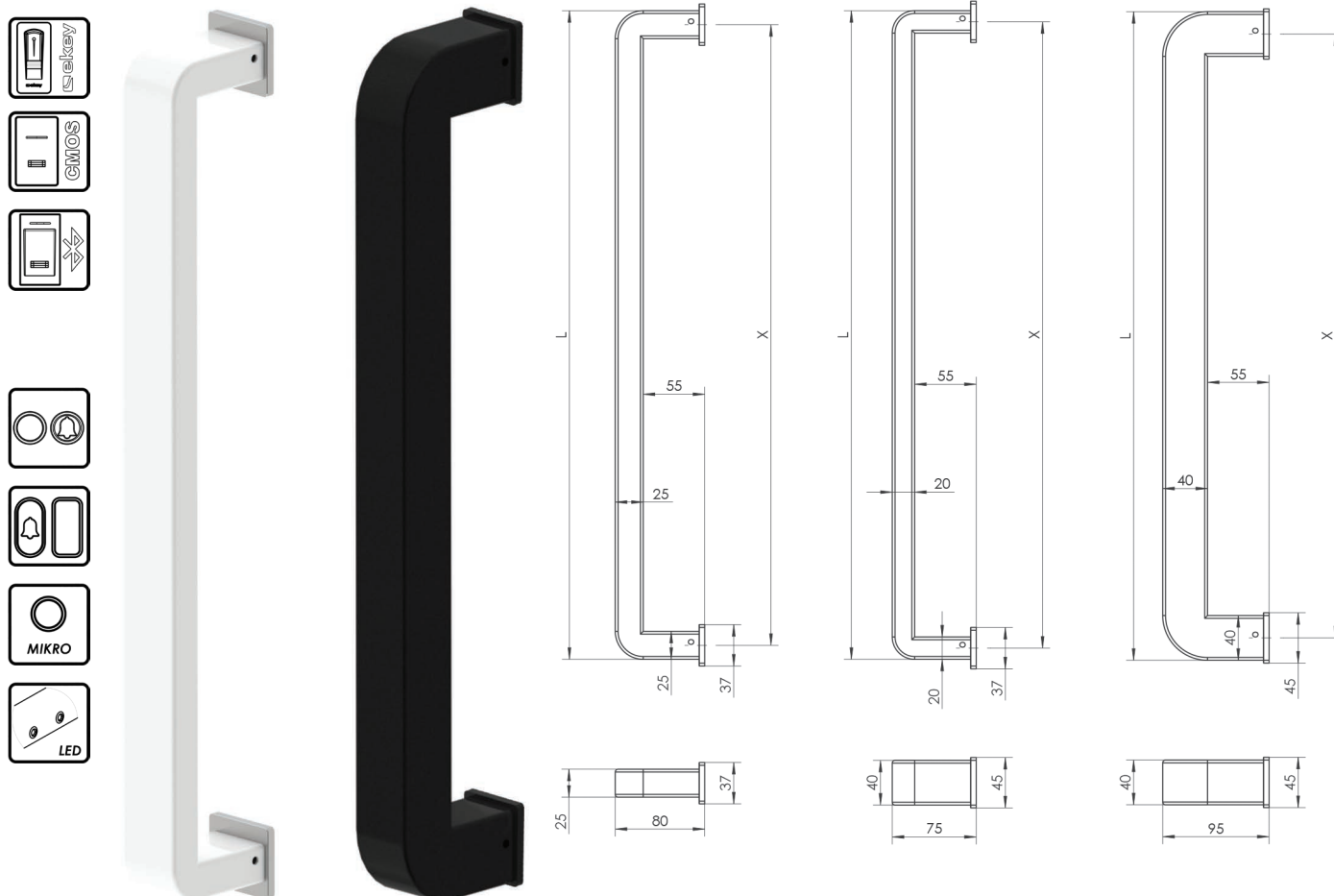

MATERIAŁ UCHWYTU	PROFIL UCHWYTU	KOD UCHWYTU	DŁUGOŚĆ L	ROZSTAW X			25x25	40x20	40x40
				25x25	40x20	40x40			
ALUMINIUM (możliwy lakier) POWIERZCHNIA CZARNY RAL 9005 BRĄZOWY RAL 8077 BRĄZOWY RAL 8019 BRĄZOWY RAL 8017 BRĄZOWY RAL 8003 ŻŁOTY W4 ŻŁOTY W3 ANTRACYT RAL 7016 BIAŁY RAL 9016 NIETYPOWY RAL		QA90C 300	300	275	280	260	✓	✓	●
		QA90C 400	400	375	380	360	✓	✓	●
		QA90C 500	500	475	480	460	✓	✓	●
		QA90C 580	580	555	560	540	✓	✓	●
		QA90C 600	600	575	580	560	✓	✓	✓
		QA90C 800	800	775	780	760	✓	✓	✓
		QA90C 1000	1000	975	980	960	✓	✓	✓
		QA90C 1200	1200	1175	1180	1160	✓	✓	✓
		QA90C 1400	1400	1375	1380	1360	○	○	✓
		QA90C 1600	1600	1575	1580	1560	○	○	✓
		QA90C 1800	1800	1775	1780	1760	○	○	✓
		QA90C 2000	2000	1975	1980	1960	○	○	✓
		QA90C 2200	2200	2175	2180	2160	○	○	✓
QA90C L x X	300-1200	L-25	L-20	L-40	●	●	●		
QA90C L x X	1201-2300	L-25	L-20	L-40	○	○	●		

- ✓ - produkt standardowy
- - produkt na specjalne, indywidualne zamówienie
- - produkt niedostępny

Pochwyty Q90CD

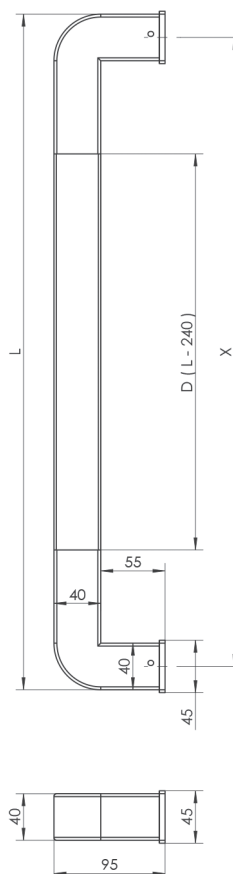

MATERIAŁ UCHWYTU			PROFIL UCHWYTU		KOD UCHWYTU	DŁUGOŚĆ L	ROZSTAW X	40x40	
STAL NIERDZEWNA 304	STAL NIERDZEWNA 316	DĄB	40	40				304	316
✓	✓	✓	1.5	40	Q90CD 800	800	760	✓	✓
✓	✓	✓	1.5	40	Q90CD 1000	1000	960	✓	✓
✓	✓	✓	1.5	40	Q90CD 1200	1200	1160	✓	✓
✓	✓	✓	1.5	40	Q90CD 1600	1600	1560	✓	✓

POWIERZCHNIA STALI



SZLIFOWANA
(DOMYŚLNA)











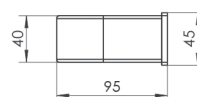
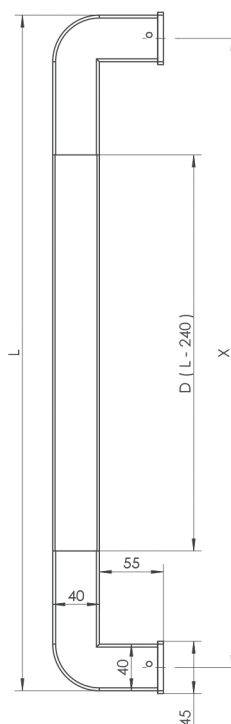

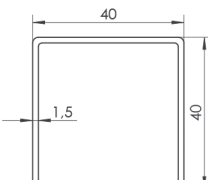

PIASKOWANA
(max 1000 mm)

- ✓ - produkt standardowy
- - produkt na specjalne, indywidualne zamówienie
- - produkt niedostępny
- * - możliwość zastosowania elektroniki tylko poza rozstawem chwytu w części metalowej uchwyty z pominięciem części drewnianej (z wyjątkiem taśmy LED)

Tralka uchwyty Q90CD standard - wykonana jest z dębu pokryta bejcą Sopur 2245 złoty dąb oraz lakierem bezbarwnym. Można również zamówić tralkę surową, malowaną na czarno lub w kolorze bejcy Sopur: Ciemny orzech (brz 22-50), Orzech (orzech 22-74), Palisander (palisander 26-01) pokryta lakierem bezbarwnym.

Pochwyty QA90CD



MATERIAŁ UCHWYTU	PROFIL UCHWYTU	KOD UCHWYTU	DŁUGOŚĆ L	ROZSTAW X	40x40
 ALUMINIUM (możliwy lakier)  DĄB		QA90CD 800	800	760	✓
POWIERZCHNIA		QA90CD 1000	1000	960	✓
 CZARNY RAL 9005  BRAZOWY RAL 8077  BRAZOWY RAL 8019  BRAZOWY RAL 8017		QA90CD 1200	1200	1160	✓
 BRAZOWY RAL 8003  ZŁOTY W4  ZŁOTY W3  ANTRACYT RAL 7016		QA90CD 1600	1600	1560	✓
 BIAŁY RAL 9016  NIETYPOWY RAL					

- ✓ - produkt standardowy
- - produkt na specjalne, indywidualne zamówienie
- - produkt niedostępny
- * - możliwość zastosowania elektroniki tylko poza rozstawem chwytu w części metalowej uchwytu z pominięciem części drewnianej (z wyjątkiem taśmy LED)

Tralka uchwytu QA90CD standard - wykonana jest z dębu pokryta bejcą Sopur 2245 złoty dąb oraz lakierem bezbarwnym. Można również zamówić tralkę surową, malowaną na czarno lub w kolorze bejcy Sopur: Ciemny orzech (brąz 22-50), Orzech (orzech 22-74), Palisander (palisander 26-01) pokryta lakierem bezbarwnym.

Pochwyty Q135

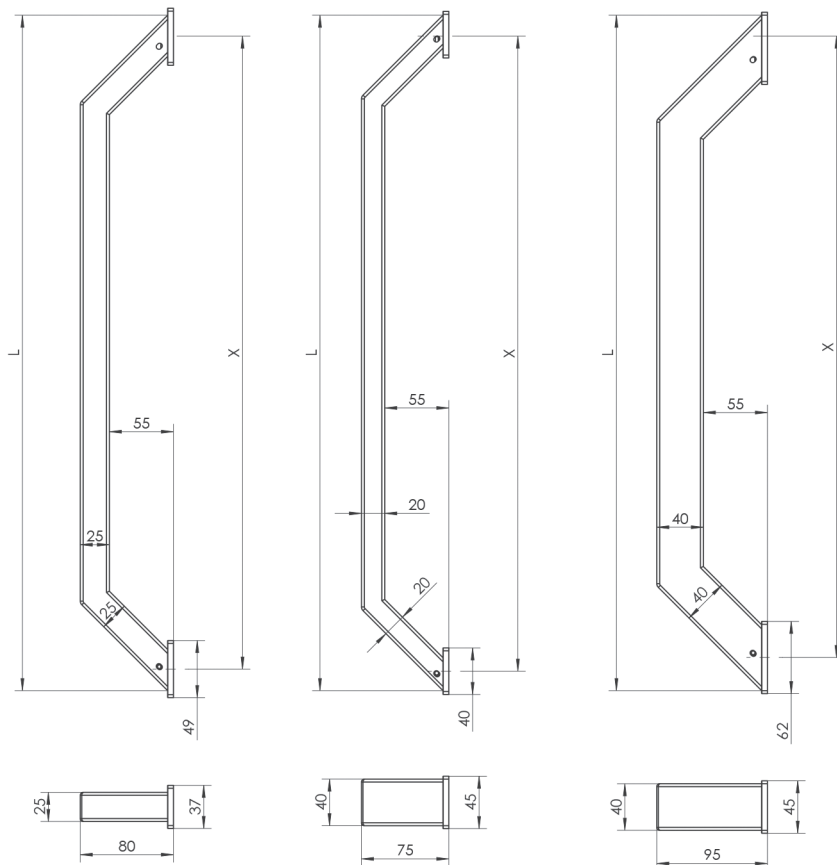
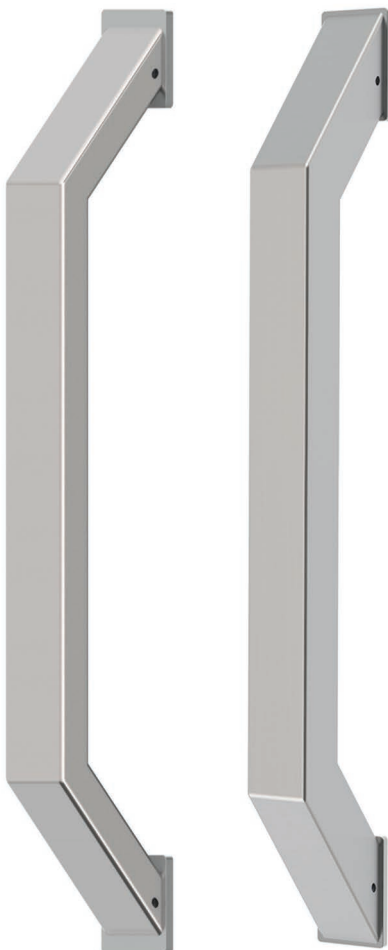

MATERIAŁ UCHWYTU		PROFIL UCHWYTU	KOD UCHWYTU	DŁUGOŚĆ L	ROZSTAW X			25x25		40x20		40x40	
STAL NIERDZEWNA 304	STAL NIERDZEWNA 316				25x25	40x20	40x40	304	316	304	316	304	316
			Q135 300	300	275	265	240	✓	✓	✓	✓	●	●
			Q135 400	400	375	365	340	✓	✓	✓	✓	●	●
			Q135 500	500	475	465	440	✓	✓	✓	✓	●	●
			Q135 580	580	555	445	420	✓	✓	✓	✓	●	●
			Q135 600	600	575	565	540	✓	✓	✓	✓	✓	✓
			Q135 800	800	775	765	740	✓	✓	✓	✓	✓	✓
			Q135 1000	1000	975	965	940	✓	✓	✓	✓	✓	✓
			Q135 1200	1200	1175	1165	1140	✓	✓	✓	✓	✓	✓
			Q135 1400	1400	1375	1365	1340	○	○	○	○	✓	✓
			Q135 1600	1600	1575	1565	1540	○	○	○	○	✓	✓
			Q135 1800	1800	1775	1765	1740	○	○	○	○	✓	✓
			Q135 2000	2000	1975	1965	1940	○	○	○	○	✓	✓
			Q135 2200	2200	2175	2165	2140	○	○	○	○	✓	✓
			Q135 L x X	300 -1200	L-25	L-35	L-60	●	●	●	●	●	●
			Q135 L x X	1201-2500	L-25	L-35	L-60	○	○	○	○	●	●

- ✓ - produkt standardowy
- - produkt na specjalne, indywidualne zamówienie
- - produkt niedostępny

Pochwyty QA135

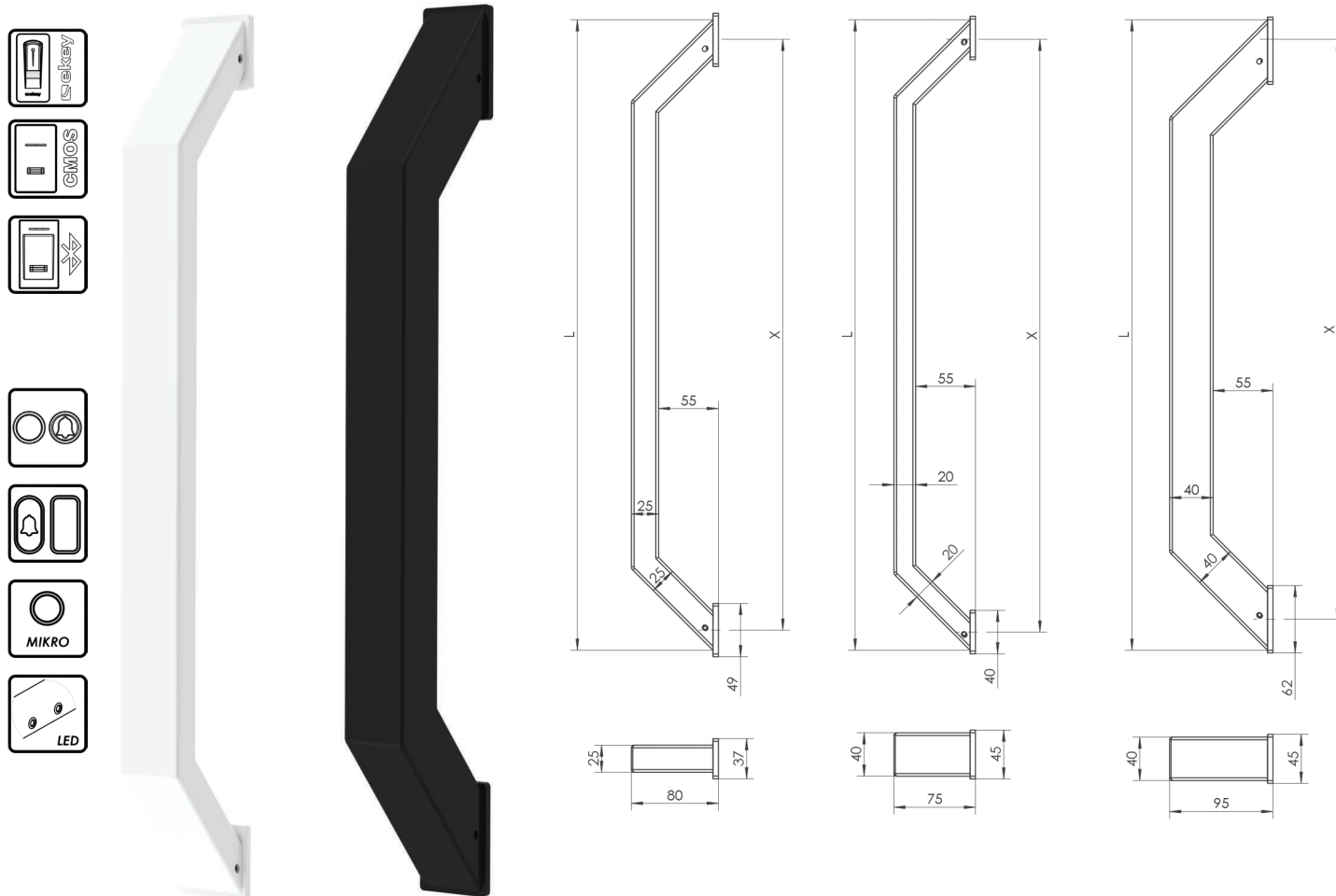



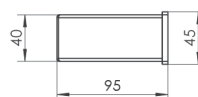
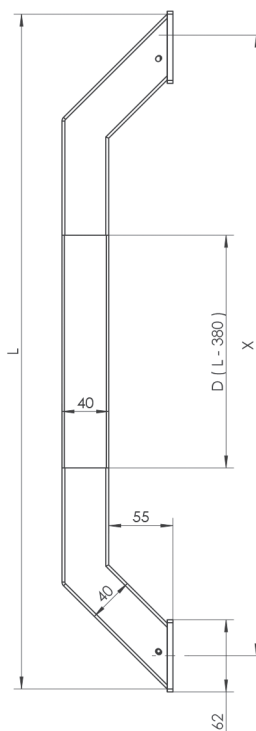

MATERIAŁ UCHWYTU	PROFIL UCHWYTU	KOD UCHWYTU	DŁUGOŚĆ L	ROZSTAW X			25x25	40x20	40x40
				25x25	40x20	40x40			
<p>ALUMINIUM (możliwy lakier)</p> <p>POWIERZCHNIA</p> <p> CZARNY RAL 9005 BRAZOWY RAL 8077 BRAZOWY RAL 8019 BRAZOWY RAL 8017 BRAZOWY RAL 8003 ZŁOTY W4 ZŁOTY W3 ANTRACYT RAL 7016 BIAŁY RAL 9016 NIETYPOWY RAL </p>		QA135 300	300	275	265	240	✓	✓	●
		QA135 400	400	375	365	340	✓	✓	●
		QA135 500	500	475	465	440	✓	✓	●
		QA135 580	580	555	445	420	✓	✓	●
		QA135 600	600	575	565	540	✓	✓	✓
		QA135 800	800	775	765	740	✓	✓	✓
		QA135 1000	1000	975	965	940	✓	✓	✓
		QA135 1200	1200	1175	1165	1140	✓	✓	✓
		QA135 1400	1400	1375	1365	1340	○	○	✓
		QA135 1600	1600	1575	1565	1540	○	○	✓
		QA135 1800	1800	1775	1765	1740	○	○	✓
		QA135 2000	2000	1975	1965	1940	○	○	✓
		QA135 2200	2200	2175	2165	2140	○	○	✓
QA135 L x X	300-1200	L-25	L-35	L-60	●	●	●		
QA135 L x X	1201-2300	L-25	L-35	L-60	○	○	●		

- ✓ - produkt standardowy
- - produkt na specjalne, indywidualne zamówienie
- - produkt niedostępny

Pochwyty QA135D

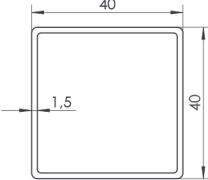









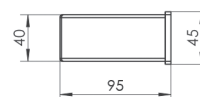
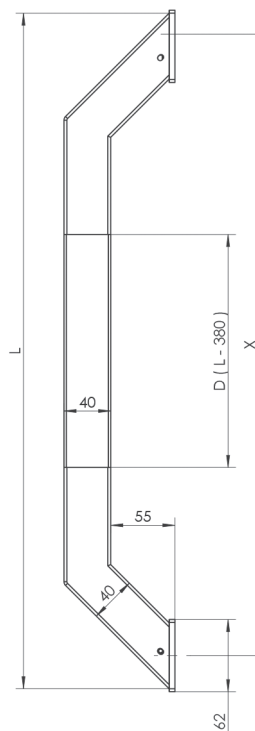

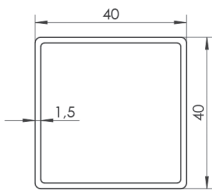

MATERIAŁ UCHWYTU			PROFIL UCHWYTU		KOD UCHWYTU	DŁUGOŚĆ L	ROZSTAW X	40x40	
STAL NIERDZEWNA 304	STAL NIERDZEWNA 316	DĄB	40	40				304	316
  				Q135D 800	800	760	✓	✓	
POWIERZCHNIA STALI				Q135D 1000	1000	960	✓	✓	
 				Q135D 1200	1200	1160	✓	✓	
SZLIFOWANA (DOMYŚLNA)				Q135D 1600	1600	1560	✓	✓	
PIASKOWANA (max 1000 mm)									

- ✓ - produkt standardowy
- - produkt na specjalne, indywidualne zamówienie
- - produkt niedostępny
- * - możliwość zastosowania elektroniki tylko poza rozstawem chwyty w części metalowej uchwytu z pominięciem części drewnianej (z wyjątkiem taśmy LED)

Tralka uchwytu Q135D standard - wykonana jest z dębu pokryta bejcą Sopur 2245 złoty dąb oraz lakierem bezbarwnym. Można również zamówić tralkę surową, malowaną na czarno lub w kolorze bejcy Sopur: Ciemny orzech (brąz 22-50), Orzech (orzech 22-74), Palisander (palisander 26-01) pokryta lakierem bezbarwnym.

Pochwyt QA135D



MATERIAŁ UCHWYTU	PROFIL UCHWYTU	KOD UCHWYTU	DŁUGOŚĆ L	ROZSTAW X	40x40
 ALUMINIUM (możliwy lakier)  DAB		QA135D 800	800	760	✓
POWIERZCHNIA		QA135D 1000	1000	960	✓
 CZARNY RAL 9005  BRAZOWY RAL 8077  BRAZOWY RAL 8019  BRAZOWY RAL 8017		QA135D 1200	1200	1160	✓
 BRAZOWY RAL 8003  ŻŁOTY W4  ŻŁOTY W3  ANTRACYT RAL 7016		QA135D 1800	1800	1560	✓
 BIAŁY RAL 9016  NIETYPOWY RAL					

- ✓ - produkt standardowy
- - produkt na specjalne, indywidualne zamówienie
- - produkt niedostępny
- * - możliwość zastosowania elektroniki tylko poza rozstawem chwytu w części metalowej uchwytu z pominięciem części drewnianej (z wyjątkiem taśmy LED)





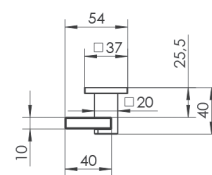
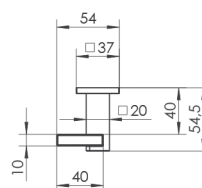
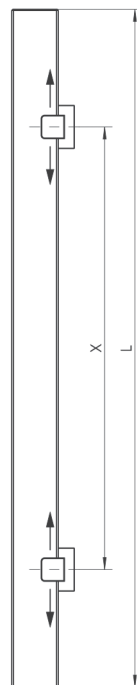
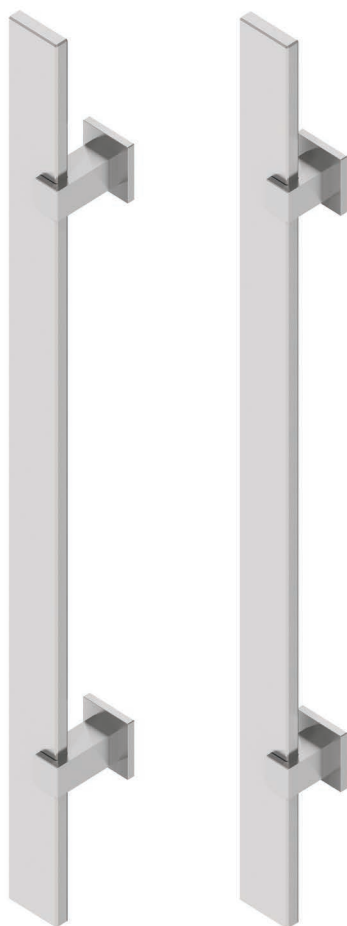





Tralka uchwytu QA135D standard - wykonana jest z dębu pokryta bejccą Sopur 2245 złoty dąb oraz lakierem bezbarwnym. Można również zamówić tralkę surową, malowaną na czarno lub w kolorze bejcy Sopur: Ciemny orzech (brąz 22-50), Orzech (orzech 22-74), Palisander (palisander 26-01) pokryta lakierem bezbarwnym.

Pochwyty QA10X



QA10X

QA10X-FR O MNIJSZEJ WYSOKOŚCI PRZEZNACZONY POD ROLETĘ

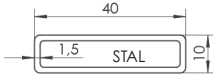
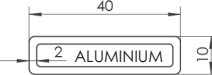
MATERIAŁ UCHWYTU	KOD UCHWYTU	DŁUGOŚĆ L	ROZSTAW X	40x10		
				AL	304	316
 STAL NIERDZEWNA 304  STAL NIERDZEWNA 316  ALUMINIUM (możliwy lakier)	QA10X L500	500	Dowolny! Nóżki można swobodnie przesuwac i dopasowac wg własnych wymagań. Można również łączyć je we wzory i używac różnych kolorów.	✓	✓	✓
	QA10X L600	600		✓	✓	✓
	QA10X L800	800		✓	✓	✓
	QA10X L1000	1000		✓	✓	✓
	QA10X L1200	1200		✓	✓	✓
	QA10X L1400	1400 (*)		✓	✓	✓
	QA10X L1600	1600 (*)		✓	✓	✓
	QA10X L1800	1800 (*)		✓	✓	✓
POWIERZCHNIA  ZŁOTY DĄB (SUBLIMACJA)  ORZECH (SUBLIMACJA)  CZARNY RAL 9005  BIAŁY RAL 9016  NIETYPOWY RAL						
POWIERZCHNIA STALI  SZLIFOWANA (DOMYŚLNA)  PIASKOWANA						
PROFIL UCHWYTU  1.5 STAL  2 ALUMINIUM						

- ✓ - produkt standardowy
- - produkt na specjalne, indywidualne zamówienie
- - produkt niedostępny
- (*) - mocowanie za pomocą 3 nóżek

Uchwyty ze sublimacją wykonywane maksymalnie do długości 1000 mm.

Pochwyty QA45X

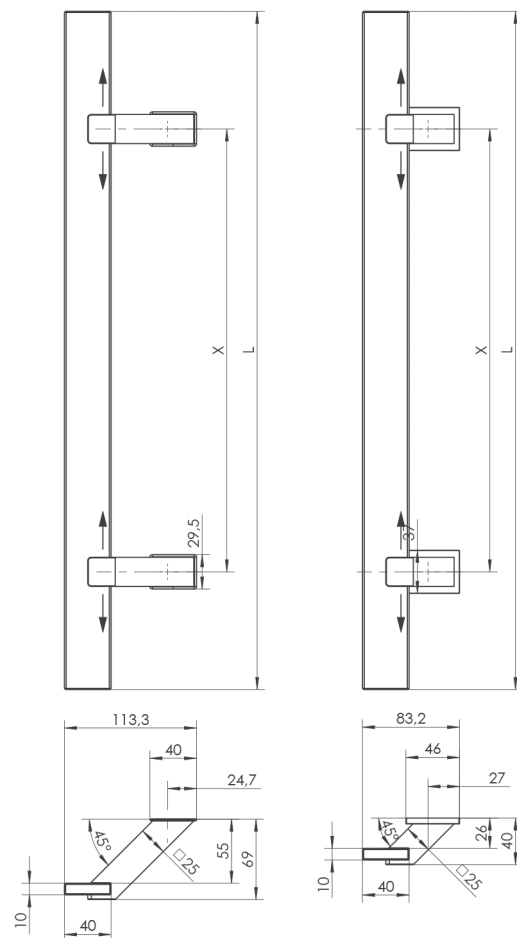

QA45X

**QA45X-FR O MNIJSZEJ WYSOKOŚCI
PRZEZNACZONY POD ROLETĘ**

QA45X

QA45X-FR

MATERIAŁ UCHWYTU	KOD UCHWYTU	DŁUGOŚĆ L	ROZSTAW X	40x10		
				AL	304	316
STAL NIERDZEWNA 304 STAL NIERDZEWNA 316 ALUMINIUM (możliwy lakier)	QA45X L500	500	Dowolny! Nóżki można swobodnie przesuwac i dopasować wg własnych wymagań. Można również łączyć je we wzory i używać różnych kolorów.	✓	✓	✓
	QA45X L600	600		✓	✓	✓
	QA45X L800	800		✓	✓	✓
	QA45X L1000	1000		✓	✓	✓
	QA45X L1200	1200		✓	✓	✓
	QA45X L1400	1400(*)		✓	✓	✓
	QA45X L1600	1600(*)		✓	✓	✓
	QA45X L1800	1800(*)		✓	✓	✓



- ✓ - produkt standardowy
- - produkt na specjalne, indywidualne zamówienie
- - produkt niedostępny
- (*) - mocowanie za pomocą 3 nóżek

Uchwyty ze sublimacją wykonywane maksymalnie do długości 1000 mm.

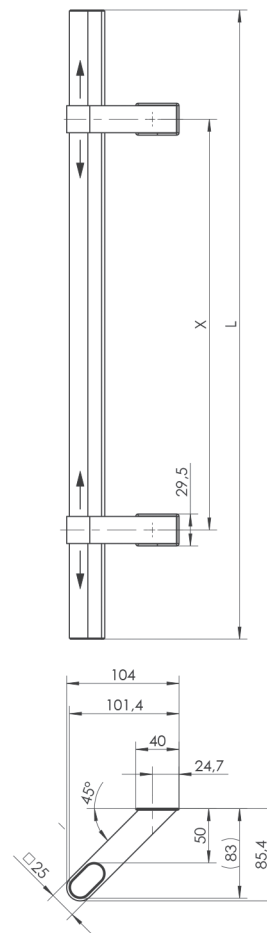
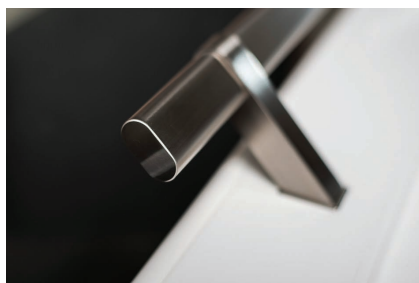
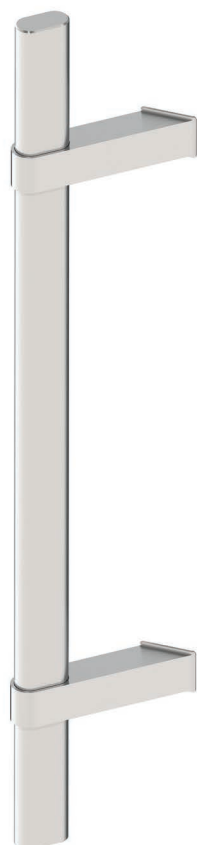

Pochwyty O45P

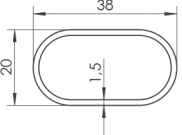

MATERIAŁ UCHWYTU		PROFIL UCHWYTU	KOD UCHWYTU	DŁUGOŚĆ L	ROZSTAW X	Owal 20x38	
POWIERZCHNIA STALI						304	316
			O45P L500	500	Dowolny! Nóżki można swobodnie przesuwac i dopasowac wg własnych wymagań.	✓	✓
STAL NIERDZEWNA 304	STAL NIERDZEWNA 316		O45P L600	600		✓	✓
			O45P L800	800		✓	✓
			O45P L1000	1000		✓	✓
			O45P L1200	1200		✓	✓
			O45P L1400	1400(*)		✓	✓
			O45P L1600	1600(*)		✓	✓
			O45P L1800	1800(*)		✓	✓

- ✓ - produkt standardowy
- - produkt na specjalne, indywidualne zamówienie
- - produkt niedostępny (możliwość wykonania nóżek ze stali 316)
- (*) - mocowanie za pomocą 3 nóżek

Pochwyty Q10ZX



Q10ZX

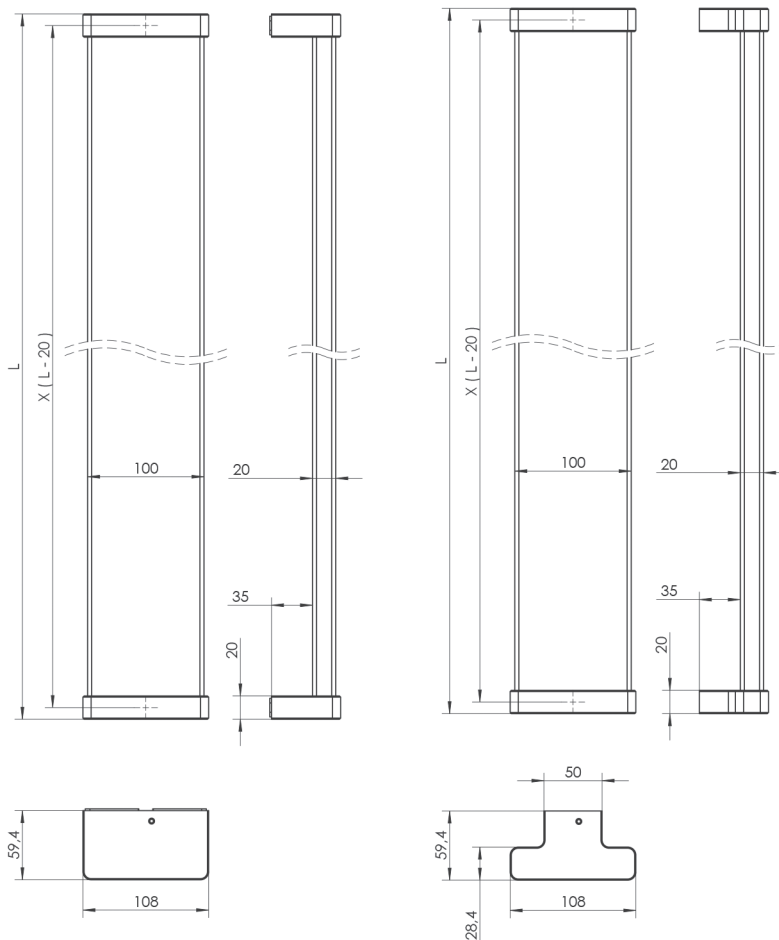

Q10ZXT

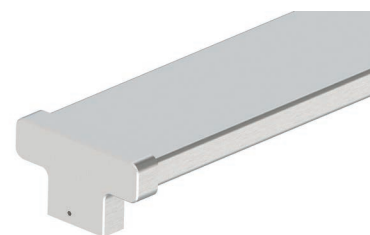

Q10ZX

Q10ZXT

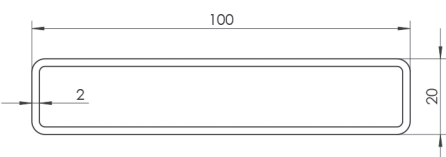

MATERIAŁ UCHWYTU	PROFIL UCHWYTU	KOD UCHWYTU	DŁUGOŚĆ L	ROZSTAW X	100x20
 STAL NIERDZEWNA 304		Q10ZX / Q10ZXT	1200	1180	✓
		Q10ZX / Q10ZXT	1600	1580	✓
POWIERZCHNIA STALI					
 SZLIFOWANA (DOMYŚLNA)		Q10ZX / Q10ZXT	1800	1780	✓
 PIASKOWANA		Q10ZX / Q10ZXT	2000	1980	✓
		Q10ZX / Q10ZXT	2200	2180	✓
		Q10ZX / Q10ZXT	2400	2380	✓
		Q10ZX / Q10ZXT	2600	2580	✓
		Q10ZX / Q10ZXT	2800	2780	✓
		Q10ZX / Q10ZXT	3000	2980	✓

- ✓ - produkt standardowy
- - produkt na specjalne, indywidualne zamówienie
- - produkt niedostępny

Pochwył PS-W

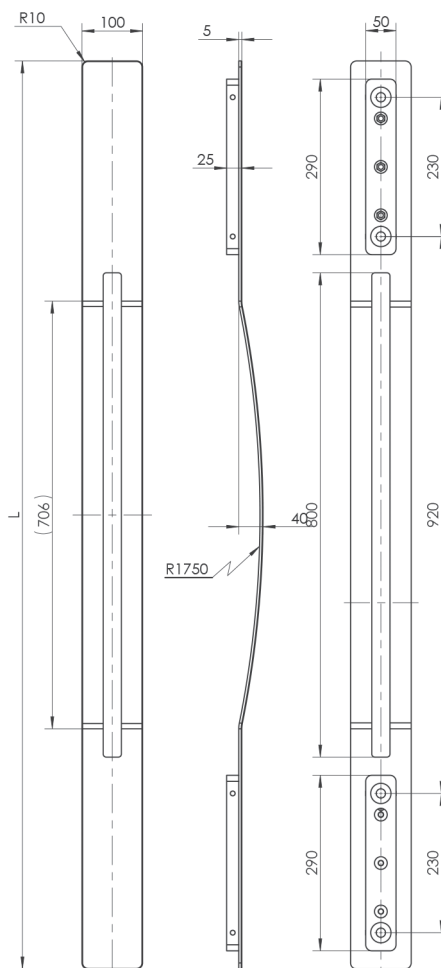
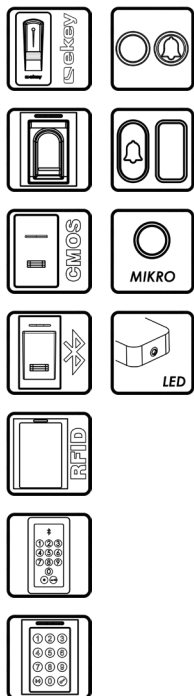

MATERIAŁ UCHWYTU	PROFIL UCHWYTU	KOD UCHWYTU	DŁUGOŚĆ L	100x5	
				304	316
STAL NIERDZEWNA 304 STAL NIERDZEWNA 316		PS-W 100 x 5 L1500	1500	✓	✓
		PS-W 100 x 5 L1800	1800	✓	✓
		PS-W 100 x 5 L2000	2000	✓	✓
		PS-W 100 x 5 L2200	2200	✓	✓
		PS-W 100 x 5 L2400	2400	✓	✓





POWIERZCHNIA STALI

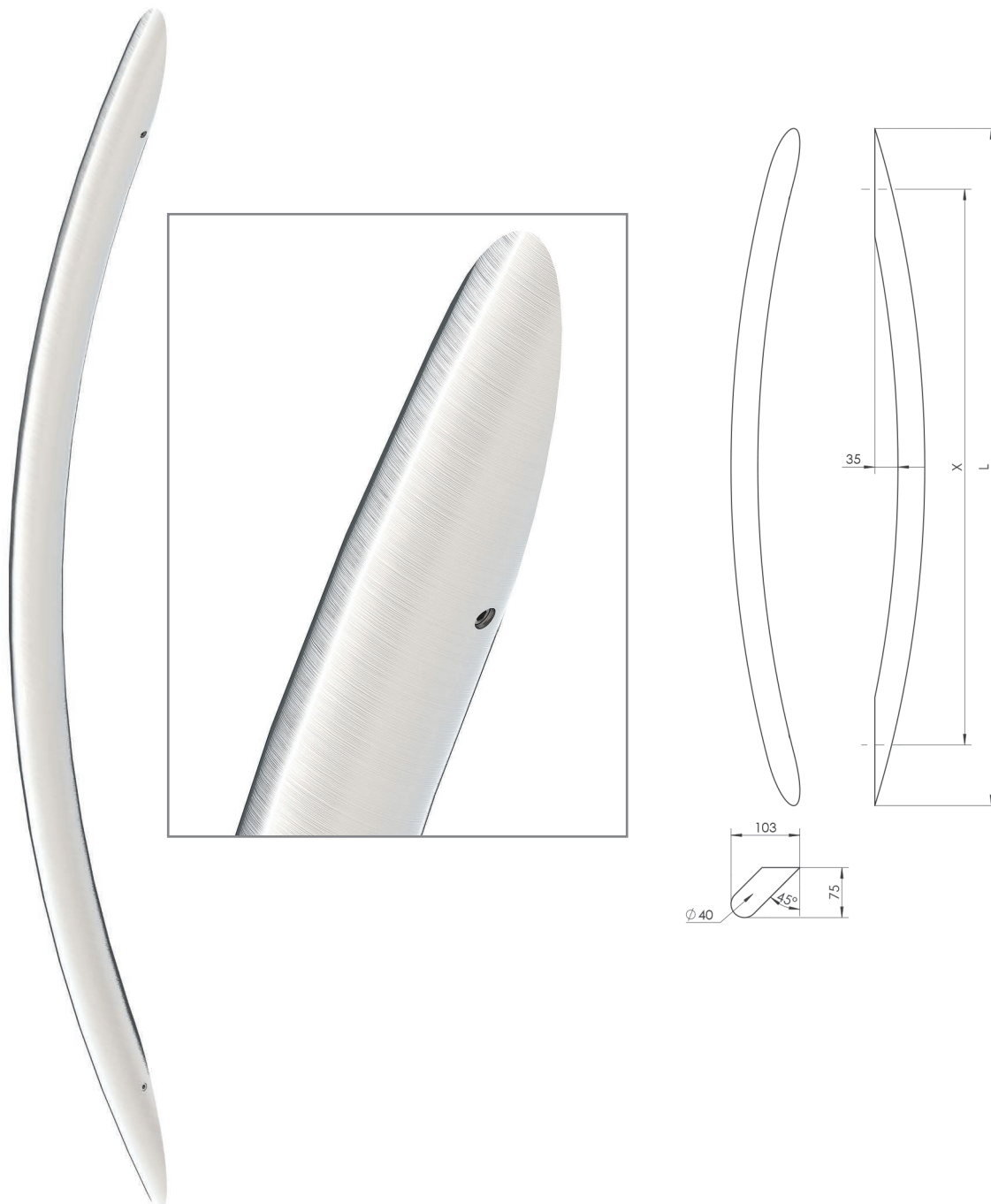

- ✓ - produkt standardowy
- - produkt na specjalne, indywidualne zamówienie
- - produkt niedostępny
- * - elektronika może być zamontowana tylko w określonych miejscach



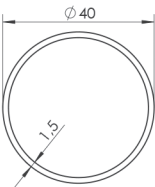

Pochwył OS

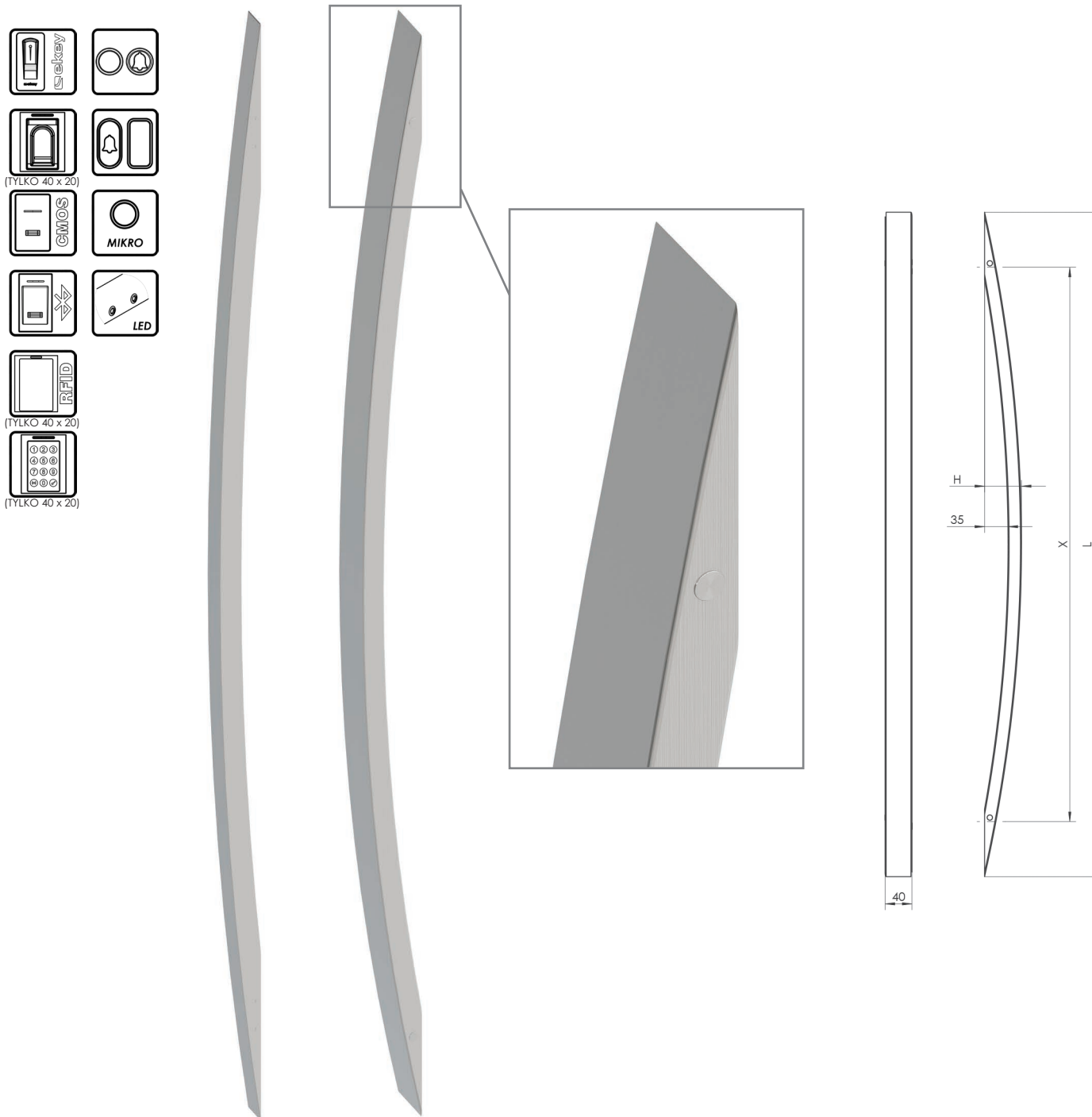

MATERIAŁ UCHWYTU		PROFIL UCHWYTU	KOD UCHWYTU	DŁUGOŚĆ L	ROZSTAW X	Ø40	
STAL NIERDZEWNA 304	STAL NIERDZEWNA 316					304	316
<div style="display: flex; justify-content: space-around;"> <div style="text-align: center;">  STAL NIERDZEWNA 304 </div> <div style="text-align: center;">  STAL NIERDZEWNA 316 </div> </div>			OS 1000 x 830	1000	830	✓	✓
POWIERZCHNIA STALI <div style="text-align: center;">  SZLIFOWANA (DOMYŚLNA) </div>			<ul style="list-style-type: none"> ✓ - produkt standardowy ● - produkt na specjalne, indywidualne zamówienie ○ - produkt niedostępny 				

Pochwyty QS

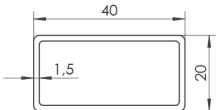

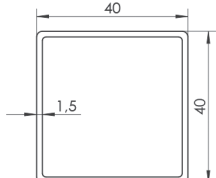
MATERIAŁ UCHWYTU		PROFIL UCHWYTU	KOD UCHWYTU	DŁUGOŚĆ L	WYSOKOŚĆ H	ROZSTAW X	40x20		40x40	
			QS 1000 x 830	1000	55	830	304	316	304	316
STAL NIERDZEWNA 304			QS 2000 x 1600	~1990	75	1600	○	○	✓	✓
STAL NIERDZEWNA 316										
POWIERZCHNIA STALI										
										
SZLIFOWANA (DOMYŚLNA)										

✓ - produkt standardowy
 ● - produkt na specjalne, indywidualne zamówienie
 ○ - produkt niedostępny
 * - elektronika może być zamontowana tylko w określonych miejscach

Zestawy mocujące

TKO JEDNOSTRONNY DO ALUMINIUM

ZESTAWY MOCUJĄCE	ZDJĘCIE	RYSUNEK
UNIWERSALNY:		
M, P60, Q60:		
Q90, Q90C:		
Q5:		
Q10X, Q10X-FR, Q5-FR:		
Q135:		

Zestawy mocujące

TKO JEDNOSTRONNY DO PCV

ZESTAWY MOCUJĄCE	ZDJĘCIE	RYСУNEK
UNIWERSALNY:		
M, P60, Q60:		
Q90, Q90C:		
Q5:		
Q10X, Q10X-FR, Q5-FR:		
Q135:		







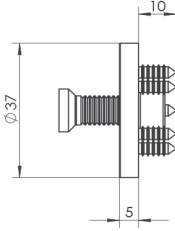

Zestawy mocujące

TKO PPOŻ. JEDNOSTRONNY

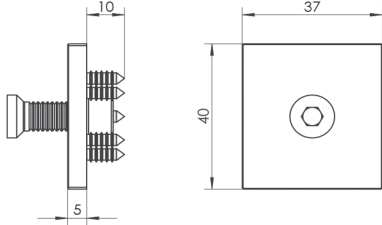
ZESTAWY MOCUJĄCE	ZDJĘCIE	RYСУNEK
UNIWERSALNY:		
M, P60, Q60:		
Q90, Q90C:		
Q5:		
Q10X, Q10X-FR, Q5-FR:		
Q135:		

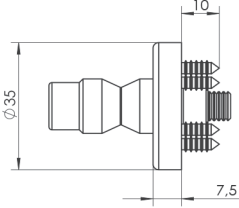
Zestawy mocujące

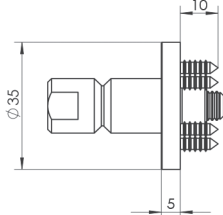
BLASZKA JEDNOSTRONNA DO ALUMINIUM

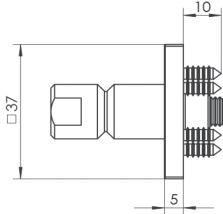
ZESTAWY MOCUJĄCE	ZDJĘCIE	RYСУNEK
UNIWERSALNY SERIA P:		
UNIWERSALNY SERIA Q:		
M, P60, Q60:		
P1, P5, P8:		
Q5:		

Zestawy mocujące

BLASZKA JEDNOSTRONNA DO ALUMINIUM

ZESTAWY MOCUJĄCE	ZDJĘCIE	RYSUNEK
Q45X, Q45P:		
Q90, Q90C:		
Q135:		
QS, Z:		
Z1N:		







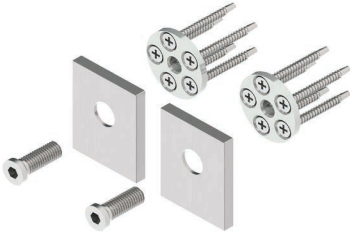
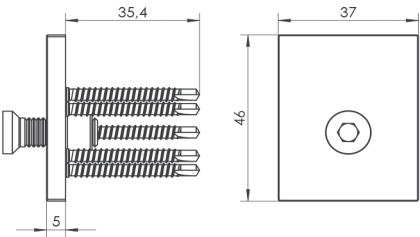

Zestawy mocujące

BLASZKA JEDNOSTRONNA DO PCV

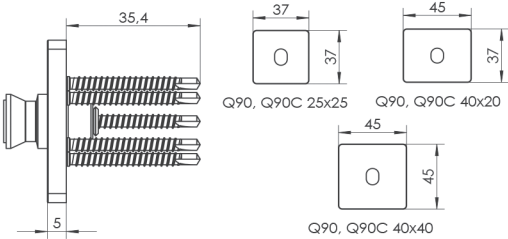
ZESTAWY MOCUJĄCE	ZDJĘCIE	RYСУNEK
UNIWERSALNY SERIA P:		
UNIWERSALNY SERIA Q:		
M, P60, Q60:		
P1, P5, P8:		
Q5:		

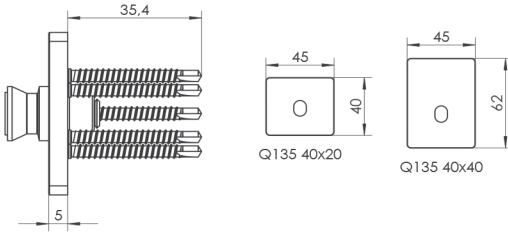

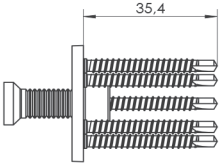

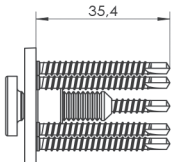

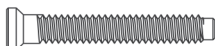

Zestawy mocujące

BLASZKA JEDNOSTRONNA DO PCV

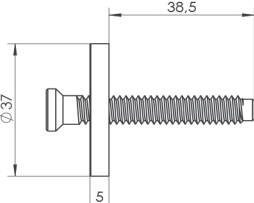
ZESTAWY MOCUJĄCE	ZDJĘCIE	RYSUNEK
Q45X, O45P:		
Q90, Q90C:		 <p>Q90, Q90C 25x25 Q90, Q90C 40x20</p> <p>Q90, Q90C 40x40</p>
Q135:		 <p>Q135 40x20 Q135 40x40</p>
QS, Z:		
Z1N:		

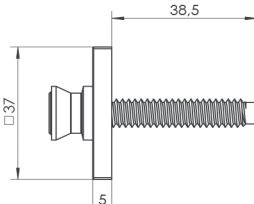
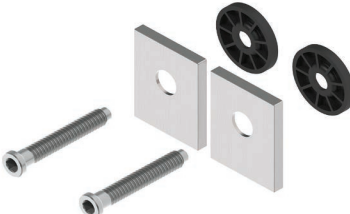
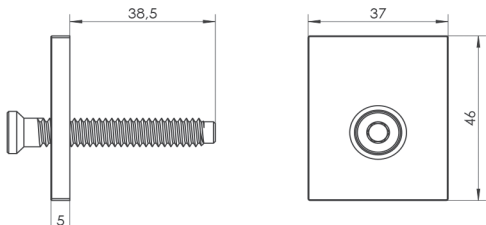

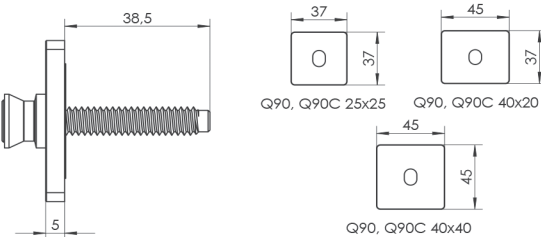

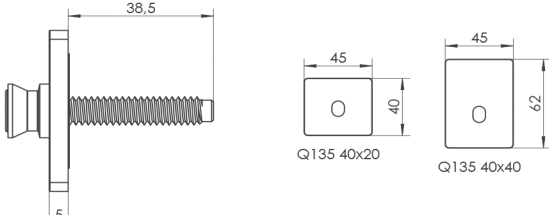

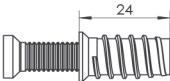

Zestawy mocujące

ŚRUBA JEDNOSTRONNY DO DREWNA

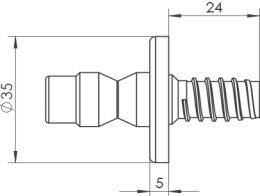
ZESTAWY MOCUJĄCE	ZDJĘCIE	RYСУNEK
UNIWERSALNY:		
P44, P44A:		
Q5-FR, Q10X, Q10X-FR:		
Q45X, O45P:		
Q90, Q90C:		
Q135:		

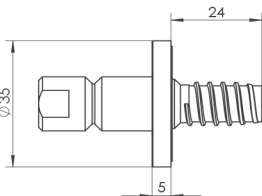
Zestawy mocujące

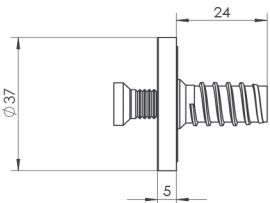
MUFA JEDNOSTRONNY DO DREWNA

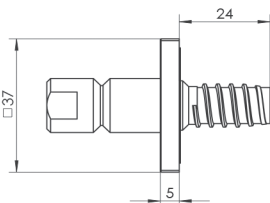
ZESTAWY MOCUJĄCE	ZDJĘCIE	RYСУNEK
UNIVERSALNY:		
M, P60, Q60:		
P1, P5, P8:		
P44, P44A:		
Q5:		

Zestawy mocujące

MUFA JEDNOSTRONNA DO DREWNA

ZESTAWY MOCUJĄCE	ZDJĘCIE	RYСУNEK
Q5-FR, Q10X, Q10X-FR:		
Q45X, O45P:		
Q90, Q90C:		
Q135:		
Z1N:		

Zestawy mocujące

PRZELOTOWO JEDNOSTRONNY

ZESTAWY MOCUJĄCE	ZDJĘCIE	RYSUNEK
UNIWERSALNY SERIA P:		
UNIWERSALNY Q, QS 40x40, Z:		
M, P60, Q60:		
P1, P5, P8:		
Q5:		

Zestawy mocujące

PRZELOTOWO JEDNOSTRONNY

ZESTAWY MOCUJĄCE	ZDJĘCIE	RYСУNEK
Q90 40x20:		<p>40 - 115mm</p> <p>37 37 45 37</p> <p>Q90, Q90C 25x25 Q90, Q90C 40x20</p> <p>45 45</p> <p>Q90, Q90C 40x40</p>
Q135 40x20:		<p>40 - 115mm</p> <p>45 40 45 62</p> <p>Q135 40x20 Q135 40x40</p>
OS, QS 40x20:		<p>45 - 115mm</p> <p>37 5</p>
Z1N:		<p>65 - 125mm</p> <p>37 5</p>



Zestawy mocujące

SZKŁO/TAFLA PRZELOTOWO JEDNOSTRONNY

ZESTAWY MOCUJĄCE	ZDJĘCIE	RYСУNEK
UNIWERSALNY SERIA P:		
UNIWERSALNY SERIA Q:		
M, P60, Q60:		
P1, P5, P8:		
Q5:		

Zestawy mocujące

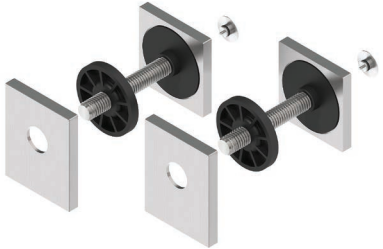
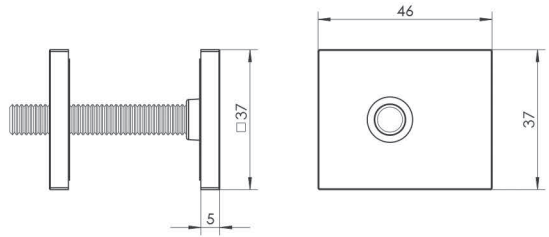
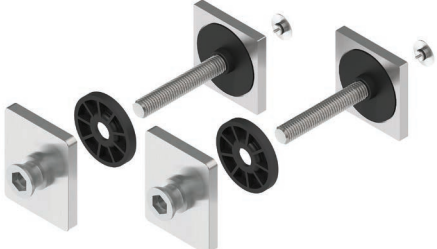
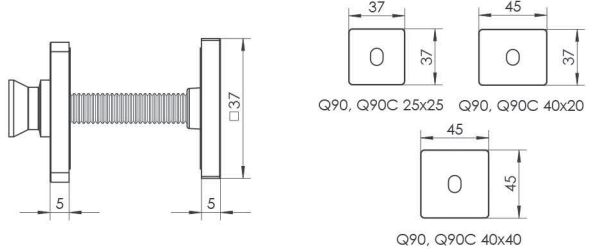
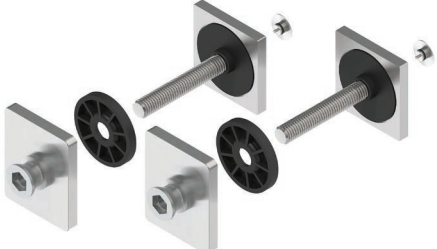
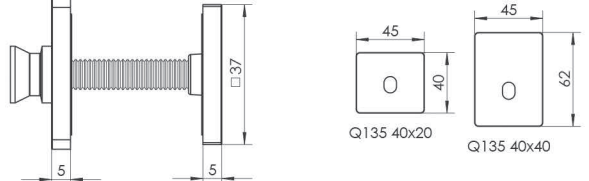
SZKŁO/TAFLA PRZELOTOWO JEDNOSTRONNY

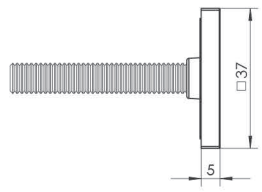
ZESTAWY MOCUJĄCE	ZDJĘCIE	RYСУNEK
Q45X, O45P:		
Q90 40x20:		
Q135 40x20:		
Z:		

Zestawy mocujące

WIERCENIA W PROFILACH

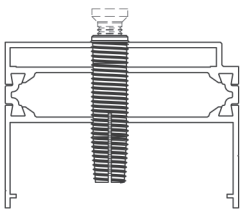
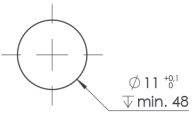
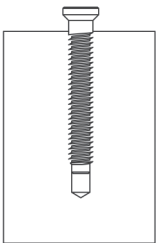
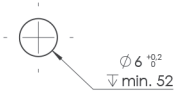
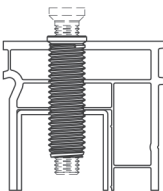
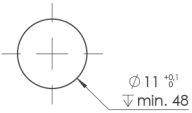
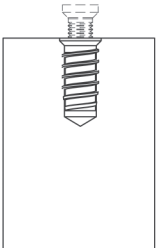
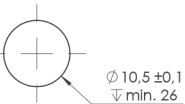
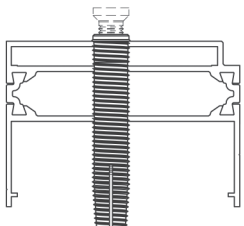
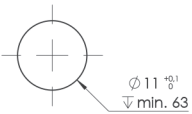
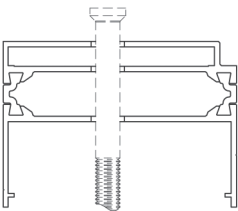
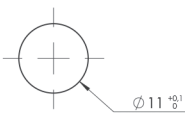
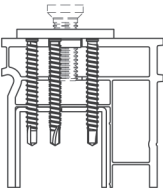
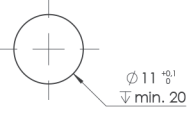
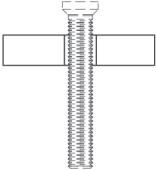
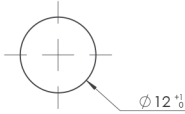
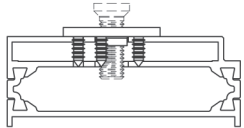
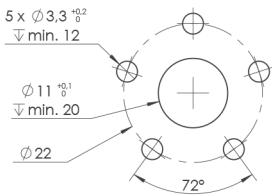
ZESTAWY MOCUJĄCE	PRZYKŁADOWE ZASTOSOWANIE	ZALECANE WIERCENIE	ZESTAWY MOCUJĄCE	PRZYKŁADOWE ZASTOSOWANIE	ZALECANE WIERCENIE
JEDNOSTRONNY TKO ALUMINIUM			JEDNOSTRONNY ŚRUBA WAŁA DO DREWNA		
JEDNOSTRONNY TKO PCV			JEDNOSTRONNY „MUFA” DO DREWNA		
TKO PRZECIWOPOŻAROWY JEDNOSTRONNY			PRZELOTOWY JEDNOSTRONNY DWUSTRONNY		
JEDNOSTRONNY BLASZKA PCV			PRZELOTOWY SZKŁO-TAFLA JEDNOSTRONNY DWUSTRONNY		
JEDNOSTRONNY BLASZKA ALUMINIUM					

Oznaczenia



czytnik biometryczny linii papilarnych firmy EKEY

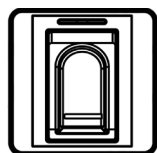

czytnik biometryczny linii papilarnych firmy IDENCOM

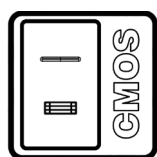

czytnik biometryczny linii papilarnych firmy IDENCOM typ CMOS

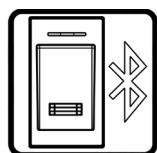

czytnik biometryczny linii papilarnych firmy IDENCOM - aplikacja Mini-X (z Bluetooth)



klawiatura numeryczna firmy IDENCOM



klawiatura dotykowa numeryczna firmy IDENCOM Bluetooth&Code

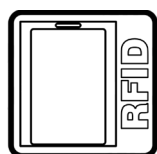

moduł RFID firmy IDENCOM



radiowy czytnik biometryczny linii papilarnych firmy FUHR

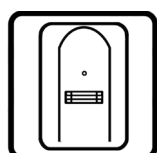

czytnik biometryczny linii papilarnych firmy Sommer - ENTRAsys

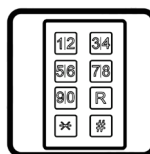

klawiatura numeryczna SOMMER ENTRAcode

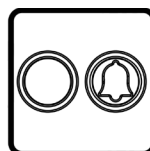

mikroprzełącznik

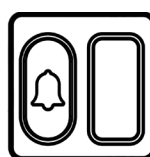

sensor dotyku



mikro sensor dotyku

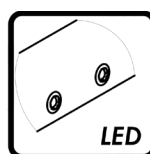

diody LED w rurze uchwytu

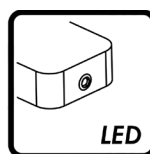

diody LED w nóżce uchwytu

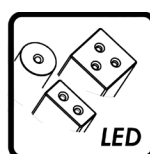

diody LED w zaślepce

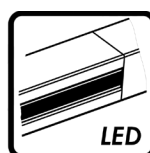

taśma LED z maskownicą

DOBÓR GATUNKU STALI:

Należy pamiętać, aby dobrać odpowiedni gatunek stali do środowiska, w którym uchwyt będzie eksploatowany:

- **AISI 304:** posiada właściwości antykorozyjne i jest odporna na normalne warunki użytkowania.
- **AISI 316:** to stal kwasoodporna, zawierająca w odróżnieniu od poprzedniej dodatek molibdenu, który poprawia właściwości antykorozyjne. Przeznaczona jest do silnie zanieczyszczonych lub agresywnych środowisk jak np.: obszary przemysłowe, strefy nadmorskie, baseny, pomieszczenia o podwyższonej wilgotności i temperaturze, w których poddawana jest na działanie czynników chemicznych tj. soli, kwasów i wysokich temperatur.

//ALUMASTER®
WINDOWS AND DOORS SOLUTIONS

 Alumaster Polska Sp. z o.o.
ul. Towarowa 7, 87-100 Toruń, Polska

 tel. +48 56 623 13 23

 alumaster@alumaster.pl
www.alumaster.pl

